

Tree farming guidelines

4th Edition (2022)

Part 2 - Silviculture

sappi



PART 2 - SILVICULTURE

Contents		Page
Chapter 1	Species	2
Chapter 2	Site-genotype matching	33
Chapter 3	Seedlings and cuttings	37
Chapter 4	Land clearing	50
Chapter 5	Site preparation	56
Chapter 6	Planting	67
Chapter 7	Fertilising	79
Chapter 8	Maintenance	84
Chapter 9	Fire protection	96
Chapter 10	Diseases & pests	109

Foresters are those strange, down-to-earth chaps of this world who protect land and plant trees. Trees for their descendants, trees for the nation, trees that, if they don't burn down, are not consumed by game, insects, or fungi, or toppled over by wind, warrants the simpleton a humble profit – provided he's still alive. (Cedric Marwick, Silvaticus, 1975)

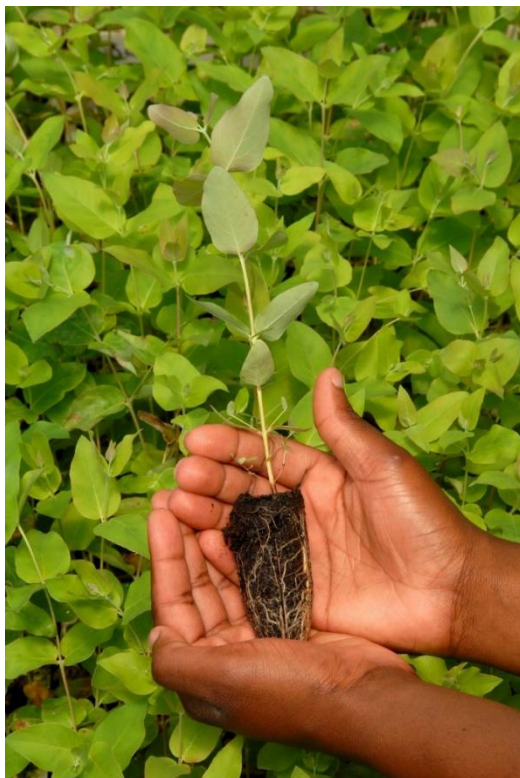

CHAPTER 1 – SPECIES	Page
1. Introduction	2
2. Eucalypts	4
2.1 <i>Eucalyptus badjensis</i>	5
2.2 <i>Eucalyptus benthamii</i>	6
2.3 <i>Eucalyptus dunnii</i>	7
2.4 <i>Eucalyptus grandis</i>	9
2.5 <i>Eucalyptus grandis x nitens</i>	11
2.6 <i>Eucalyptus grandis x urophylla</i>	13
2.7 <i>Eucalyptus macarthurii</i>	15
2.8 <i>Eucalyptus nitens</i>	17
2.9 <i>Eucalyptus smithii</i>	19
3. Black wattle <i>Acacia mearnsii</i>	21
4. Pines	24
4.1 <i>Pinus patula</i>	25
4.2 <i>Pinus elliottii</i>	27
4.3 <i>Pinus taeda</i>	28
4.4 <i>P. patula x P. tecunumanii</i> LE (PPTL)	29
4.5 <i>P. patula x P. tecunumanii</i> HE (PPTH)	31
4.6 <i>P. elliottii x P. caribaea</i> var. <i>hondurensis</i> (PECH)	32

1. Introduction

Following several species introductions and trials conducted by various research organisations over many years, the current commercial species in South Africa consist of three main genera, i.e., *Eucalyptus*, *Acacia* and *Pinus*.

Many species of eucalypt are fast growing and produce high value timber with particular qualities. *E. globulus* was the first of the eucalypts to become widely known outside Australia. The first account of introductions of *E. globulus* to the Cape Colony was in 1828. By 1865 the Colonial Botanist reported that more than twenty-one species of eucalypt had been introduced to the Cape. Pioneers such as Fourcade and Hutchins recognised the importance of matching climatic conditions from elsewhere in the world with that of South Africa when considering exotic species.

Since 1930 most seed were supplied by various state forestry departments and other organisations in Australia with the appropriate collection and site details well documented. This allowed for a more scientific approach to species testing in South Africa which laid a good foundation for tree breeding programmes locally.¹

In Australia, only about 60 eucalypts out of the full complement of species (over 700) are classed as being economically important producers of timber.¹ Historically, *Eucalyptus grandis* has been the most important hardwood for the South African forestry industry. The objectives of growing eucalypts have now polarised more into growing short-rotation pulpwood for kraft² and dissolving pulp. This has led to the expansion of hardwoods into the colder sites where *E. grandis* does not survive. Typically, cold tolerant eucalypts are suited to sites above 1200m, which are prone to frost and frequent snowfalls. In the sub-tropics, tropics and to a lesser extent in the more temperate zones, eucalypt hybrids have become a significant component of plantation forestry. Some species are also suitable for a longer rotation management of solid wood.³

The first introductions of *Acacia mearnsii* (black wattle) into South Africa from Australia were done in 1864 with the first plantings established ten years later for firewood, shelterbelts, and shade for livestock.⁴ Establishment of black wattle continued and in 1888 tests conducted on

the bark concluded that the vegetable tannins were of a high quality and suitable for leather tanning. This led to the establishment of plantations to produce bark for the export market.⁵

Apart from the commercial value of its bark, the timber is used for firewood and building purposes, and products such as parquet flooring blocks, furniture, hardboard, rayon, charcoal, structural timber, and fencing poles. In recent years more emphasis has been placed on the timber for pulp production for both local and external markets. Establishment programmes generally target the poorer site qualities for *Acacia mearnsii*. Being a legume, this species will enhance soil fertility through nitrogen fixing.⁶

Regarding pines, the first commercial plantations consisted of *Pinus pinaster* and *Pinus pinea* and were established between 1825 and 1830 at Genadendal, Western Cape. Sir David Hutchins, Conservator of Forests for the Cape, introduced *Pinus patula* into South Africa in 1907 when a trial block was planted at Tokai plantation in the Western Cape Province.⁷ *P. patula* is indigenous to Mexico and is the most important softwood species in commercial forestry in South Africa.

The genus *Pinus* comprises approximately 100 taxonomically distinct species and many hybrids, varieties, and cultivars.⁷ Their natural distribution includes most of the Northern Hemisphere and is almost entirely absent south of the equator.

References

¹ Poynton, RJ (1979) Tree planting in Southern Africa. Vol. 2. The eucalypts. Department of Forestry, Pretoria. p 882.

² Low CB & Shelbourne CJA (1999) Performance of *Eucalyptus globulus*, *E. maidenii*, *E. nitens* and other eucalypts in Northland and Hawke's Bay at ages 7 and 11 years. New Zealand Journal of Forestry Science 29: p 27,42,88.

² Clarke CRE & Jones W (1998) Cold Tolerant Eucalypt Programme Breeding Manual. Sappi Shaw Research Centre.

^{3a} Low CB & Shelbourne CJA (1999) Performance of *Eucalyptus globulus*, *E. maidenii*, *E. nitens* and other eucalypts in Northland and Hawke's Bay at ages 7 and 11 years. New Zealand Journal of Forestry Science 29: p 27,42,88.

^{3b} Griffin AR (2001) Deployment decisions: Capturing the benefits of tree improvement with clones and seedlings. Proceedings of Developing the Eucalypt of the Future. IUFRO Working Party 2.08.03, Valdivia, Chile. Invited paper. p 34.

⁴ Sherry SP (1971) The black wattle (*Acacia mearnsii* de Wild). University of Natal Press, Pietermaritzburg, South Africa. p 402.

⁵ Jarman RD & Lloyd-Jones GA (1982) The Wattle industry in South Africa: A survey for students. Wattle Research Institute Document 12/82. Typescript.

⁶ Dunlop RW (2002) Black Wattle: The South African Research Experience. Wattle Handbook chapter 1 Introduction. Institute for Commercial Forestry Research, Pietermaritzburg, South Africa.

⁷ Poynton RJ (1977) Tree planting in Southern Africa. Vol. 1. The pines. Department of Forestry, Pretoria.

sappi

2. Eucalypts



2.1 *Eucalyptus badjensis*

Summary	<i>Eucalyptus badjensis</i> is taxonomically closely related to species such as <i>E. benthamii</i> , <i>E. smithii</i> and <i>E. macarthurii</i> and best suited to cooler sites. While not as frost hardy as <i>E. macarthurii</i> it can tolerate mild frost and snow events. It is ideally suited to sites in the summer rainfall regions of South Africa with a mean annual temperature (MAT) of between 13.0 -16.0 °C in the cool temperate (CT) and the warm temperate cool (WTC) zones. A mean annual precipitation (MAP) of over 825mm is for optimum growth. Feeding by <i>Gonipterus</i> sp. 2 (snout beetle) has been observed on <i>E. badjensis</i> . This species will coppice well but is susceptible to wind damage. It has thinner bark than species such as <i>E. macarthurii</i> but has better stripping ability. Wood density ranges from average to high with pulping properties suitable for both dissolving and kraft processes.					
Province	KwaZulu-Natal			Mpumalanga		
	✓			✓		
MASL range (m)	>1200			>1300		
MAP range (mm)	> 825					
MAT range (°C)	13.0 -16.0					
Soil depth (cm)	35+					
Silvicultural Zones¹	ST	WTW	WTC	CTW	CTC	
	✗	✗	✓	✓	✓	
Site Quality²	SQ1	SQ2	SQ3	SQ4	SQ5	
	✓	✓	✓	✓	✗	
Abiotic tolerance	Frost	Snow	Wind	Drought	Hail	
	Moderate-High	Moderate	Moderate	Moderate-Low	Moderate	
Pest and Disease tolerance	<i>Leptocybe invasa</i>	<i>Gonipterus</i> sp. 2	<i>Botryosphaeriaceae</i>	<i>Phytophthora</i> spp.	Other	
		High	High	Moderate		
Other characteristics of commercial value	Coppice potential	Stem defects and poor form	Bark stripping	Flowering		
	High	Moderate (forking can occur)	Moderate-High	Age until flowering	Annual flowering times	
				10 years (in plantation espacement)	May to July	
Wood quality	Density		Pulp yield		Wood pulpability*	
	Moderate-High		Moderate		Medium	
Markets/Uses	Dissolving pulp	Kraft pulp	Saw timber	Poles	Other	
	✓**	✓	✗		Limited bee keeping and honey production	
Comments and References	✓ Acceptable ✗ Not acceptable Only acceptable if the first-choice species or variety is not available No data available			* Cooking speed of the wood chips at Saiccor mill ** Accepted at Saiccor ¹ refer Part 2 Silviculture Chapter 2 ² refer Part 1 Forest management Chapter 3		

Jan 2022

2.2 *Eucalyptus benthamii*

Summary	<i>Eucalyptus benthamii</i> is taxonomically closely related to species such as <i>E. badjensis</i> , <i>E. smithii</i> and <i>E. macarthurii</i> and best suited to cooler sites. While not snow tolerant due to stem breakages <i>E. benthamii</i> has similar frost tolerance potential as <i>E. macarthurii</i> . It is ideally suited to sites in the summer rainfall regions of South Africa with a mean annual temperature (MAT) of between 13.0 - 16.0 °C in the cool temperate (CT) ¹ and the warm temperate cool (WTC) zones. A mean annual precipitation (MAP) of over 825mm is for optimum growth. <i>E. benthamii</i> is prone to attack by <i>Gonipterus</i> sp. 2 (snout beetle). This species will coppice well but is susceptible to wind damage. It has thinner bark than species such as <i>E. macarthurii</i> which improves the stripping ability. Wood density ranges from average to high with pulping properties suitable for both dissolving and kraft processes.				
Province	KwaZulu-Natal		Mpumalanga		
	✓		✓		
MASL range (m)	>1200		>1300		
MAP range (mm)	> 825				
MAT range (°C)	13.0 -16.0				
Soil depth (cm)	35+				
Silvicultural Zones¹	ST	WTW	WTC	CTW	CTC
	✗	✗	✓	✓	✓
Site Quality²	SQ1	SQ2	SQ3	SQ4	SQ5
	✓	✓	✓	✓	✓
Abiotic tolerance	Frost	Snow	Wind	Drought	Hail
	High	Low	Moderate	Moderate-Low	Moderate
Pest and Disease tolerance	<i>Leptocybe invasa</i>	<i>Gonipterus</i> sp. 2	<i>Phytophthora</i> sp.	<i>Botryosphaeriaceae</i>	Other
		Moderate-Low	Moderate	High	Susceptible to cutworm damage
Other characteristics of commercial value	Coppice potential	Stem defects and poor form	Bark stripping	Flowering	
	High	Moderate (forking can occur)	Moderate-High	Age until flowering	Annual flowering times
				5 years (in plantation espacement)	May to July
Wood quality	Density		Pulp yield		Wood pulpability*
	Moderate-High		Moderate-Low		Medium
Markets/Uses	Dissolving pulp	Kraft pulp	Saw timber	Poles	Other
	✓**	✓	✗	✗	Good bee keeping potential and honey production
Comments and References	<ul style="list-style-type: none"> ✓ Acceptable ✗ Not acceptable 😞 Only acceptable if the first-choice species or variety is not available No data available 			<ul style="list-style-type: none"> * Cooking speed of the wood chips at the Saiccor Mill ** Accepted at Saiccor and Ngodwana (testing in progress) ¹ refer Part 2 Silviculture Chapter 2 ² refer Part 1 Forest management Chapter 3 	

Jan 2022

2.3 *Eucalyptus dunnii*

Summary	<i>Eucalyptus dunnii</i> is ideally suited to sites in the summer rainfall regions of South Africa. It grows better than <i>E. grandis</i> on cooler sites and has better frost tolerance. <i>E. dunnii</i> is classified as mildly drought tolerant, moderate-to-low tolerance to frost and snow damage. <i>E. dunnii</i> is susceptible to <i>Gonipterus</i> sp. 2 (snout beetle) and <i>Phoracantha</i> spp. (long horned beetles) when under drought stress. Over the years, <i>E. dunnii</i> has remained relatively disease free with a few recorded cases of Botryosphaeria canker and die-back which appear following environmental stresses such as drought, frost, or hail. <i>E. dunnii</i> will coppice well but is susceptible to wind damage. Its bark is rough and persistent at the base and thin to fibrous above, which strips relatively easily. <i>E. dunnii</i> has an above average density with a range of pulping properties suitable for both dissolving and kraft processes, making this species highly profitable for the mills. Juvenile leaves are discoloured, sessile to shortly petiolate, while mature leaves are petiolate, concolourous and moderately reticulate that appear usually after 12 months.					
Province	KwaZulu-Natal			Mpumalanga		
	✓			✓		
MASL range (m)	400 – 1500			1000-1700		
MAP range (mm)	825–950					
MAT range (°C)	15.1–20.0					
Soil depth (cm)	35+					
Silvicultural Zones¹	ST	WTW	WTC	CTW	CTC	
	✗	✓	✓	✓	😞	
Site Quality²	SQ1	SQ2	SQ3	SQ4	SQ5	
	n/a	✓	✓	✓	✓	
Abiotic tolerance	Frost	Snow	Wind	Drought	Water-logged soils	
	Moderate-High	Moderate-Low (stem breakage)	Moderate-Low	Moderate-High	Moderate	
Pest and Disease tolerance	<i>Leptocybe invasa</i>	<i>Teratosphaeria destructans</i>	<i>Gonipterus</i> sp. 2	<i>Phytophthora</i> spp.	<i>Thaumastocoris peregrinus</i>	Other
	High	High	Low	High	Moderate	Prone to <i>Phoracantha</i> spp. attack when drought stressed. Resistant to termites.

Other characteristics of commercial value	Coppice potential	Stem defects and poor form	Bark stripping	Age until flowering	Flowering
	Moderate	Low	Easy	8 years (in plantation espacement)	Annual flowering times
Wood quality	Density		Pulp yield		Wood pulpability*
	High		Moderate-High		Medium
Markets/Uses	Dissolving pulp	Kraft pulp	Saw timber	Poles	Other
	✓**	✓	😞	😞	Some potential for bee keeping and honey production
Comments and References	✓ Acceptable ✗ Not acceptable 😞 Only acceptable if the first-choice species or variety is not available ⓘ No data available		* Cooking speed of the wood chips at Saiccor Mill ** Accepted at Saiccor and GoCell (Ngodwana) ¹ refer Part 2 Silviculture Chapter 2 ² refer Part 1 Forest management Chapter 3		

Jan 2022

2.4 Eucalyptus grandis

Summary	<p><i>Eucalyptus grandis</i> is ideally suited to sites in the summer rainfall regions of South Africa. It is classified as sub-tropical but also grows well on sites in the warm temperate region, that are free from frost or snow. <i>E. grandis</i> is susceptible to various pathogens such as <i>Chrysosporthe austroafricana</i> which causes mortality in the first two years following establishment and <i>Teratosphaeria zuluensis</i> (<i>Coniothyrium</i> stem canker) in subtropical regions. It is also susceptible to <i>Leptocybe invasa</i> (gall wasp), which has reduced the popularity of this species. <i>E. grandis</i> will coppice well and is ideal for second rotation coppice crops. The bark is rough and persistent at the base, but thin and flaking for the rest of the trunk. It strips easily throughout the year but is susceptible to drought which does negatively affect the stripping ability. This species has a lower density relative to all other commercial eucalypts but has both good kraft and dissolving pulp properties. Juvenile leaves are discoloured and petiolate, while mature leaves are discoloured, petiolate and alternate and usually appear at 12 months.</p>					
Province	KwaZulu-Natal			Mpumalanga		
	✓			✓		
MASL range (m)	100 - 1300			600 - 1400		
MAP range (mm)	900 +					
MAT range (°C)	16.5–20					
Soil depth (cm)	60+					
Silvicultural Zones¹	ST	WTW	WTC	CTW	CTC	
	✓	✓	✓	☹️	✗	
Site Quality²	SQ1	SQ2	SQ3	SQ4	SQ5	
	✓	✓	✓	✗	✗	
Abiotic risk tolerance	Frost	Snow	Wind	Drought	Water-logged soils	
	Low	Low	Moderate	Low	Moderate	
Pest and Disease tolerance	<i>Leptocybe invasa</i>	<i>Teratosphaeria destructans</i>	<i>Gonipterus</i> sp. 2	<i>Coniothyrium</i> stem canker (cankers)	<i>Thaumastocoris peregrinus</i>	Other
	Low	Moderate	Moderate	Low	Moderate	Susceptible to <i>Cryosporthe austroafricana</i>
Other characteristics of commercial value	Coppice potential	Stem defects and poor form	Bark stripping	Flowering		
	High	Low	Easy (variable during drought)	Age until flowering	Annual flowering times	
				3 years (in plantation espacement)	January to April (Subtropical) March to August (Temperate)	
Wood quality	Density		Pulp yield		Wood pulpability*	
	Low-Moderate		Moderate-High		Medium	

sappi

Markets/Uses	Dissolving pulp	Kraft pulp	Saw timber	Poles	Other
	✓**	✓	✗	✓	Good bee keeping and honey production potential
Comments and References	<ul style="list-style-type: none"> ✓ Acceptable ✗ Not acceptable 😞 Only acceptable if the first-choice species or variety is not available 📘 No data available 			<ul style="list-style-type: none"> *Cooking speed of the wood chips at the Saiccor Mill **Accepted at Saiccor and GoCell (Ngodwana) ¹ refer Part 2 Silviculture Chapter 2 ² refer Part 1 Forest management Chapter 3 	
					Jan 2022

2.5 *Eucalyptus grandis x nitens*

Summary	<p><i>Eucalyptus grandis x nitens</i> (GN) hybrid varieties remain an important option due to site specific adaptability. These varieties are ideally suited to sites in the warm temperate cool (WTC) to the cool temperate cool (CTC) zones within the summer rainfall regions of South Africa. A mean annual temperature (MAT) of between 13.0°C to 16.0°C and mean annual precipitation (MAP) of over 850mm are optimum for growth. The GN hybrid is fast growing and specifically developed to tolerate both abiotic and biotic stresses. Typically, varieties display certain levels of frost and snow tolerance and selecting the correct genotype for sites subject to these events is important. Similarly, pests such as <i>Leptocybe invasa</i> (gall forming wasp) and defoliators such as <i>Gonipterus</i> sp. 2 (snout beetle) will attack and defoliate certain varieties. Diseases are less common but <i>Botryosphaeria</i> stem cankers, <i>Phytophthora</i> root rot and <i>Teratosphaeria destructans</i> may have an impact. Although GN varieties coppice well, after one rotation a new variety will most likely replace it due to the better growth and or tolerance to both abiotic and biotic stresses. These genotypes generally strip well, with average to above average density and suitable pulping properties for both dissolving and kraft processes. Current commercial varieties include PP2107, NH58, NH70, SGN5011, SGN5016, SGN5019, SGN5025, and SGN5028. Refer to the table below for the description of the genotype.</p>					
Province	KwaZulu-Natal			Mpumalanga		
	✓			✓		
MASL range (m)	> 1000			> 1200		
MAP range (mm)	850 and above					
MAT range (°C)	13 - 16					
Soil depth (cm)	35+					
Silvicultural Zones¹	ST	WTW	WTC	CTW	CTC	
	✗	✗	✓	✓	✓	
Site Quality²	SQ1	SQ2	SQ3	SQ4	SQ5	
	✓	✓	✓	✓	✓	
Abiotic tolerance	Frost	Snow	Wind	Drought	Hail	
	PP2107, NH58, NH70, SGN5011, 16, 28 = Moderate; SGN5019 = Low; SGN5025 = 1	PP2107, SGN5011, 16 = Moderate; NH58 = Low; SGN5019, 25, 28, NH70 = 1	Moderate	Moderate	Moderate	
Pest and Disease tolerance	<i>Leptocybe invasa</i>	<i>Gonipterus</i> sp. 2	<i>Botryosphaeriaceae</i>	<i>Phytophthora</i> sp.	<i>Teratosphaeria destructans</i>	Other
	NH58, NH70, SGN5011, 16, 19, 25, 28 = High; PP2107 = Low;	Moderate-High	High	High	Moderate-High	High
Other characteristics of commercial value	Coppice potential	Stem defects and poor form	Bark stripping	Flowering		
	High	Low	High	Age until flowering	Annual flowering times	
				4+	April to September	
Wood quality	Density		Pulp yield		Wood pulpability*	
	PP2107, NH58, NH70 = Moderate-High; SGN5011, 16 = Moderate; SGN5019, 25, 28 = 1		PP2107, NH58 = Moderate-High; NH70 = Moderate; SGN5011, 16, 19, 25, 28 = 1		PP2107 = Fast; NH58 = Slow; SGN5011, 16, 19, 25, 28, NH70 = 1	

sappi

	Dissolving pulp	Kraft pulp	Saw timber	Poles	Other
Markets/Uses	✓**	✓	😞	✓	Good bee keeping and honey production potential
Comments and References	<ul style="list-style-type: none"> ✓ Acceptable ✗ Not acceptable 😞 Only acceptable if the first-choice species or variety is not available 📌 No data available 		<ul style="list-style-type: none"> *Cooking speed of the wood chips at Saiccor mill **Accepted at Saiccor; Trials at GoCell (Ngodwana). ¹ refer Part 2 Silviculture Chapter 2 ² refer Part 1 Forest management Chapter 3 		Jan 2022

2.6 *Eucalyptus grandis x urophylla*

Summary	<p><i>Eucalyptus grandis x urophylla</i> (GU) hybrid varieties remain an important option due to site specific adaptability. These varieties are ideally suited to sites in the sub-tropical and warm temperate zones within the summer rainfall regions of South Africa. A mean annual temperature (MAT) of greater than 18.0°C and mean annual precipitation (MAP) of over 950mm are optimum for growth. The GU hybrid is fast growing and specifically developed to tolerate a high level of disease pressure. Diseases typically include Coniothyrium stem canker and Destructans leaf blight. Recently some GU varieties have been found susceptible to Ceratocystis wilt disease. Pests that may impact some GU varieties include <i>Leptocybe invasa</i> (gall forming wasp) and <i>Gonipterus</i> sp. 2 (snout beetle). Although GU varieties coppice well, after one rotation a new variety will most likely replace it due to the better growth and or tolerance to both abiotic and biotic stresses. These genotypes generally strip well, with average density and suitable pulping properties for both dissolving and kraft processes. Current commercial varieties include SGU2561, SGU2563, SGU2564, SGU2565 and SGU2569. Refer to the table below for the description of the genotype.</p>					
Province	KwaZulu-Natal			Mpumalanga		
	✓			✓		
MASL range (m)	0 - 900			750 -1100		
MAP range (mm)	950 and above					
MAT range (°C)	18 - 21					
Soil depth (cm)	35+					
Silvicultural Zones¹	ST	WTW	WTC	CTW	CTC	
	✓	✓	✗	✗	✗	
Site Quality²	SQ1	SQ2	SQ3	SQ4	SQ5	
	✓	✓	✓	✓	✓	
Abiotic tolerance	Frost	Snow	Wind	Drought	Water-logged soils	
	Low	N/A	Moderate	Moderate	Moderate	
Pest and Disease tolerance	<i>Leptocybe invasa</i>	<i>Gonipterus sp2</i>	<i>Cryphonectria</i>	<i>Teratosphaeria destructans</i>	<i>Ceratocystis</i>	Other
	High	Moderate	High	High	High	
Other characteristics of commercial value	Coppice potential	Stem defects and poor form	Bark stripping	Flowering		
	High	Low	High	Age until flowering	Annual flowering times	
				3+	December to June	
Wood quality	Density	Pulp yield		Wood pulpability*		
	Moderate	Moderate-High		SGU2561,63,64,65= Medium; SGU2569=Slow		
Markets/Uses	Dissolving pulp	Kraft pulp	Saw timber	Poles	Other	
	✓**	✓	😞	✓	Bee keeping; honey production	

Comments and References	✓ Acceptable ✗ Not acceptable 😞 Only acceptable if the first-choice species or variety is not available 📄 No data available	*Cooking speed of the wood chips at Saiccor mill **Accepted at Saiccor; Trials at GoCell (Ngodwana). ¹ refer Part 2 Silviculture Chapter 2 ² refer Part 1 Forest management Chapter 3 Jan 2022
--------------------------------	--	---

2.7 *Eucalyptus macarthurii*

Summary	<i>Eucalyptus macarthurii</i> is ideally suited to sites in the summer rainfall regions of South Africa and is classified as cold tolerant, however the growth rate decreases when planted in areas with a MAT below 14.5°C. <i>E. macarthurii</i> is the most frost hardy of all the commercial eucalypt species but is susceptible to stem breakage following mild to heavy snowfalls. <i>E. macarthurii</i> is relatively disease free due to its thick bark and is moderately tolerant to pests such as <i>Gonipterus</i> , <i>Thaumastocoris</i> and <i>Glycaspis</i> . <i>E. macarthurii</i> will coppice well and is ideal for second rotation coppice crops. Its bark is rough and persistent over most of the trunk and strips relatively easily during summer but with difficulty during winter. This species has above average density and the potential for suitable kraft and dissolving pulp properties following breeding and selection. Juvenile leaves are sessile, amplexicaul and slightly discolourous, while mature leaves are petiolate and narrow-lanceolate and usually appear at 12 months.					
Province	KwaZulu-Natal			Mpumalanga		
	✓			✓		
MASL range (m)	900 - 1700			1200 - 1950		
MAP range (mm)	800+					
MAT range (°C)	13.1 – 16.0					
Soil depth (cm)	40+					
Silvicultural Zones¹	ST	WTW	WTC	CTW	CTC	
	X	✓	✓	✓	✓	
Site Quality²	SQ1	SQ2	SQ3	SQ4	SQ5	
	n/a	✓	✓	✓	✓	
Abiotic risk tolerance	Frost	Snow	Wind	Drought	Water-logged soils	
	High	Low	Moderate-Low	Moderate-High	Moderate	
Pest and Disease tolerance	<i>Leptocybe invasa</i>	<i>Glycaspis brimblecombei</i>	<i>Gonipterus</i> sp. 2	<i>Phytophthora</i> spp.	<i>Thaumastocoris peregrinus</i>	Other
	High	Moderate	Moderate	Moderate	Moderate	Resistant to Termites; susceptible to <i>Botryosphaeria</i> - appears following environmental stresses such as drought, frost, or hail.
Other characteristics of commercial value	Coppice potential	Stem defects and form	Bark stripping	Flowering		
	High	Moderate	Variable (Site and season)	Age until flowering	Annual flowering times	
				6 years (in plantation espacement)	June to November	
Wood quality	Density	Pulp yield		Wood pulpability*		
	High	Moderate (site specific)		Fast		
Markets/Uses	Dissolving pulp	Kraft pulp	Saw timber	Poles	Other	
	☹️	☹️	☹️	☹️	Bee keeping; Honey production	

<p>Comments and References</p>	<ul style="list-style-type: none"> ✓ Acceptable ✗ Not acceptable ☹ Only acceptable if the first-choice species or variety is not available 📄 No data available 	<p>*Cooking speed of the wood chips at Saiccor Mill **Accepted at Saiccor; Trials at GoCell (Ngodwana) ¹ refer Part 2 Silviculture Chapter 2 ² refer Part 1 Forest management Chapter 3</p> <p style="text-align: right;">Jan 2022</p>
---------------------------------------	--	---

2.8 Eucalyptus nitens

Summary	This species ideally is suited to cooler, high altitude sites in the summer rainfall regions of the country. <i>Eucalyptus nitens</i> is classified as frost tolerant, but not as hardy as <i>E. macarthurii</i> , with good snow tolerance. <i>E. nitens</i> is susceptible to various forms of leafspot (e.g., <i>Mycosphaerella</i> caused by fungi in the <i>Teratosphaeriaceae</i>) in its juvenile state, especially when planted on warmer sites. <i>Botryosphaeria</i> stem canker and die-back may appear following environmental stress such as drought, frost, or hail. <i>E. nitens</i> in recent years has become highly susceptible to <i>Coryphodema tristis</i> , an indigenous cossid moth, which has markedly reduced the popularity of this species. <i>E. nitens</i> does not coppice well and the ability to coppice decreases with age. Its bark is rough and persistent at the base and strips relatively easily. <i>E. nitens</i> has good kraft pulping properties, but less desirable properties for dissolving pulp. Juvenile leaves are discolorous, sessile and stems are square, while mature leaves are concolourous, petiolate and alternate and usually appear at 12 months.					
Province	KwaZulu-Natal		Mpumalanga			
	✓		✓			
MASL range (m)	1150 - 1700		1400 - 1950			
MAP range (mm)	850 +					
MAT range (°C)	13.1 – 15.0					
Soil depth (cm)	70 +					
Silvicultural Zones¹	ST	WTW	WTC	CTW	CTC	
	✗	✗	✗	😞	✓	
Site Quality²	SQ1	SQ2	SQ3	SQ4	SQ5	
	✓	✓	✓	✗	✗	
Abiotic tolerance	Frost	Snow	Wind	Drought	Water-logged soils	
	Moderate - High	High	Moderate	Low	Moderate	
Pest and Disease tolerance	<i>Teratosphaeriaceae</i> leaf spot	<i>Phytophthora</i> spp.	<i>Gonipterus</i> sp. 2	<i>Coryphodema tristis</i>	<i>Leptocybe invasa</i>	<i>Botryosphaeria</i> canker
	Low	Low	Moderate	Low	High	Moderate
Other characteristics of commercial value	Coppice potential	Stem defects and poor form	Bark stripping	Flowering		
	Low	Moderate	High	Age until flowering	Annual flowering times	
				8 years (in plantation espacement)	April to November	
Wood quality	Density		Pulp yield		Wood pulpability*	
	Moderate-High		Moderate		Slow	
Markets/Uses	Dissolving pulp	Kraft pulp	Saw timber	Poles	Other	
	😞	✓	✗	✗	Some potential for bee keeping and honey production	

<p>Comments and References</p>	<ul style="list-style-type: none"> ✓ Acceptable ✗ Not acceptable ☹ Only acceptable if the first-choice species or variety is not available 📄 No data available 	<p>*Cooking speed of the wood chips at the Saiccor Mill **Accepted at Saiccor and GoCell (Ngodwana). ¹ refer Part 2 Silviculture Chapter 2 ² refer Part 1 Forest management Chapter 3</p> <p style="text-align: right;">Jan 2022</p>
---------------------------------------	--	---

2.9 *Eucalyptus smithii*

Summary	<i>Eucalyptus smithii</i> is ideally suited to deep well drained soils on cool temperate sites in the summer rainfall regions of South Africa. <i>E. smithii</i> is classified as cold tolerant, and moderately tolerant to frost and snow. <i>E. smithii</i> is susceptible <i>Phytophthora</i> root rot, particularly in the first two years of growth. Its bark is rough and persistent over most of the trunk and strips relatively easily during summer. <i>E. smithii</i> has above average density and good pulp properties. Although this species is of high value to the mills, it has been classified as a fast cooker making it difficult to blend with other species (medium cookers) in the digesters. <i>E. smithii</i> is also a problematic species in the nursery and has subsequent issues at establishment; therefore, this species is being largely replaced with <i>E. grandis</i> x <i>E. nitens</i> hybrid clones, which are faster growing and do not present with the above-mentioned issues. Juvenile leaves of <i>E. smithii</i> are discoloured, sessile and lanceolate, while mature leaves, which appear at around 12 months, are narrow-lanceolate, discoloured, petiolate and alternate.					
Region	KwaZulu-Natal		Mpumalanga		Kingdom of Eswatini	
	✓		☹️		✓	
MASL range (m)	900 – 1500		1200 - 1500		1100 - 1500	
MAP range (mm)	830–950					
MAT range (°C)	15 – 17					
Soil depth (cm)	> 40					
Silvicultural Zones¹	ST	WTW	WTC	CTW	CTC	
	✗	☹️	✓	✓	✗	
Site Quality²	SQ1	SQ2	SQ3	SQ4	SQ5	
	✓	✓	✓	✗	✗	
Abiotic risk tolerance	Frost	Snow	Wind	Drought	Water-logged soils	
	Moderate	Moderate	Moderate	Low	Low	
Pest and Disease tolerance	<i>Leptocybe invasa</i>	<i>Teratosphaeria destructans</i>	<i>Gonipterus</i> sp. 2	<i>Phytophthora</i> spp.	<i>Thaumastocoris peregrinus</i>	Other
	High	High	Moderate-Low	Low	Moderate	<i>Botryosphaeria</i> will appear following environmental stresses such as drought, frost, or hail.
Other characteristics of commercial value	Coppice potential	Stem defects and poor form	Bark stripping	Flowering		
	High	Moderate	Moderate	Age until flowering	Annual flowering times	
				8 years (in plantation espacement)	January to April	
Wood quality	Density		Pulp yield		Wood pulpability*	
	High		High		Fast	

sappi

	Dissolving pulp	Kraft pulp	Saw timber	Poles	Other
Markets/Uses	✓**	✓	😞	✗	Essential oils; some potential for bee keeping and honey production
Comments and References	<ul style="list-style-type: none"> ✓ Acceptable ✗ Not acceptable 😞 Only acceptable if the first-choice species or variety is not available 📘 No data available 			<ul style="list-style-type: none"> *Cooking speed of the wood chips at Saiccor Mill **Accepted at Saiccor; Laboratory trials for GoCell (Ngodwana). ¹ refer Part 2 Silviculture Chapter 2 ² refer Part 1 Forest management Chapter 3 	
					Jan 2022

sappi

3. Black wattle *Acacia mearnsii*



3. *Acacia mearnsii*

Summary	<p><i>Acacia mearnsii</i> is ideally suited to sites in the summer rainfall regions of South Africa. It grows well from sub-tropical to the warm temperate cool regions, that are free from frost or snow. <i>A. mearnsii</i> as a commercial species has the added benefit of producing both timber and bark each with its own unique properties and markets. It requires intensive management from early establishment through to scheduling felling operations to get the full benefit for the two products available, with harvesting usually scheduled for the wet season. <i>A. mearnsii</i> is susceptible to a host of pest and diseases through the rotation and is subject to seasonal attacks, typically at establishment white grubs, cutworm and termites can be problematic followed by <i>Phytophthora</i> root rot in certain areas. Other problems that can occur at varying levels include wattle rust, bagworm, mirid, looper and brown lappet moth. Other diseases include <i>Ceratocystis</i> wilt, <i>Botryosphaeria</i> stem cankers and pink disease that can lead to mortality. Wattle has above average wood density and pulp yield relative to other commercial hardwoods. It is suitable for the dissolving pulp process.</p>					
Province	KwaZulu-Natal			Mpumalanga		
	✓			✓		
MASL range (m)	300 - 1300			600 - 1500		
MAP range (mm)	850 - 1200					
MAT range (°C)	16.0 – 20.0					
Soil depth (cm)	60+					
Silvicultural Zones¹	ST	WTW	WTC	CTW	CTC	
	✗	✓	✓	✗	✗	
Site Quality²	SQ1	SQ2	SQ3	SQ4	SQ5	
	✓	✓	✓	✗	✗	
Abiotic risk tolerance	Frost	Snow	Wind	Drought	Water-logged soils	
	Low	Low	Moderate	Moderate	Low	
Pest and Disease tolerance	<i>Uromycladium acaciae</i>	<i>Phytophthora</i> (root rot)	<i>Botryosphaeria</i> (cankers) <i>Erythricium salmonicolor</i>	<i>Ceratocystis</i> (wilt)	<i>Botrytis</i> (nursery)	<i>Noctuidae</i> <i>Scarabaeidae</i> <i>Kotochalia junodi</i> <i>Lydidolon laevigatum</i>
	Low	Moderate	Moderate	Low	Moderate	Low-moderate
Other characteristics of commercial value	Coppice potential	Stem defects and poor form	Bark stripping	Flowering		
	✗	High	Easy (only summer)	Age until flowering	Annual flowering times	
				3 years	August to October	
Wood quality	Density		Pulp Yield		Wood pulpability*	
	Moderate-High		Moderate-High		✓	

Markets/Uses	Dissolving pulp	Kraft pulp	Bark	Poles	Other
	✓**	✗	✓	Low value construction	Bark
Comments and References	✓ Acceptable; ✗ Not acceptable 😞 Only acceptable if the first-choice species or variety is not available ⓘ No data available			*Cooking speed of the wood chips at the Saiccor Mill **Accepted at Saiccor ¹ refer Part 2 Silviculture Chapter 2 ² refer Part 1 Forest management Chapter 3 Jan 2022	

4. Pines



Mexican pine (*Pinus patula*)

4.1 Pinus patula

Summary	<p><i>Pinus patula</i> is indigenous to Mexico at altitudes of 1,500 to 3,100m and at latitudes 16°N to 24°N with mean annual precipitation of between 600 and 2,500mm. Within its native range it attains a height of 35m and diameters of up to 80 cm. <i>P. patula</i> is the most widely planted species in the <i>Oocarpae</i> subsection with an approximate one million hectares established worldwide. The broad growth requirements for this species in South Africa are MAT of <18°C and MAP of >700mm at high altitudes and >950mm at lower altitudes with well-drained soils. The greatest threats to <i>P. patula</i> in South Africa are the fungal pathogens <i>Diplodia sapinea</i> (blue stain, cankers, die-back), <i>Fusarium circinatum</i> (transplant mortality, pitch canker) and <i>Rhizina undulata</i> (post fire death), and the insect pests <i>Hylastes angustatus</i> (bark beetle), <i>Pissodes nemorensis</i> (weevil) and <i>Sirex noctilio</i> (woodwasp). <i>P. patula</i> grows rapidly, captures the site quickly and is moderately resistant to drought and frost events. The good wood quality makes it suitable for a range of solid wood and pulp products.</p>					
Province	KwaZulu-Natal			Mpumalanga		
	✓			✓		
MASL range (m)	850 - 1700			1000 - 1950		
MAP range (mm)	>850					
MAT range (°C)	13 - 17					
Soil depth (cm)	30 on saprolite, 60+ on rocky soils					
Silvicultural Zones¹	ST	WTW	WTC	CTW	CTC	
	✗	✗	✓	✓	✓	
Site Quality²	SQ1	SQ2	SQ3	SQ4	SQ5	
	✓	✓	✓	✓	✓	
Abiotic tolerance	Frost	Snow	Wind	Drought	Water-logged soils	
	Moderate	Moderate	Moderate	Moderate	Low	
Pest, Disease and Fire tolerance	<i>Fusarium circinatum</i>	<i>Sirex noctilio</i>	<i>Diplodia sapinea</i>	<i>Pissodes</i>	Fire	Other
	Low	Low (in high density plantings, e.g., pulp)	Low	Moderate	Low	Baboon damage is common
Other characteristics of commercial value	Coppice potential	Stem defects and poor form	Bark stripping	Flowering		
	n/a	Low	n/a	Age until flowering		Annual flowering times
				3 years (in plantation espacement)		August to September
Wood quality	Density		Pulp yield		Wood pulpability*	
	Low-Moderate		Moderate-High		High	

sappi

Markets/Uses	Dissolving pulp	Kraft pulp	Saw timber	Newsprint	Other
	✘	✔	✔	✔	Veneer
Comments and References	✔ Acceptable ✘ Not acceptable 😞 Only acceptable if the first-choice species or variety is not available ⓘ No data available			*Suitable for kraft pulp ¹ refer Part 2 Silviculture Chapter 2 ² refer Part 1 Forest management Chapter 3 <div style="text-align: right;">Jan 2022</div>	

4.2 *Pinus elliottii*



Summary	<i>Pinus elliottii</i> , commonly known as slash pine, is an important timber tree species native to the lower coastal plain within the south-eastern USA. Trees grow up to 36 m in height and 0.9 m in diameter, producing a long, clear bole. Because of its rapid early growth and production of highly valuable wood products, it has been widely introduced into other countries. As an exotic, it is used in Africa, especially southern Africa, and in Australia and South America for various products, ranging from lumber to pulpwood. Suitable to wet, soft plinthic subsoils, fire tolerant and resistant to <i>Diplodia sapinea</i> (canker/die back) and <i>Fusarium circinatum</i> (pitch canker fungus).					
Province	KwaZulu-Natal ✓			Mpumalanga ✓		
MASL range (m)	0 - 1700			350 - 1950		
MAP range (mm)	700–900					
MAT range (°C)	14+					
Soil depth (cm)	40+					
Silvicultural Zones¹	ST ✗	WTW ✓	WTC ✓	CTW ✓	CTC ✓	
Site Quality²	SQ1 ✓	SQ2 ✓	SQ3 ✓	SQ4 ✓	SQ5 ✓	
Abiotic tolerance	Frost Moderate	Snow Moderate	Wind Moderate	Drought Moderate	Water-logged soils High	
Pest, Disease and Fire tolerance	<i>Fusarium circinatum</i> High	<i>Sirex noctilio</i> Moderate-High in RSA	<i>Diplodia sapinea</i> High	<i>Rhizina undulata</i> Moderate	Fire Moderate	Animal damage High
Other characteristics of commercial value	Coppice potential n/a	Stem defects and poor form Low	Bark Used for nursery medium	Flowering Age until flowering Annual flowering times 8 years (in plantation espacement) June to July		
Wood quality	Density Moderate		Pulp yield Moderate-High		Wood pulpability* Moderate-High	
Markets/Uses	Dissolving pulp ✗	Kraft pulp ✓	Saw timber ✓	Newsprint 😞	Other Veneer	
Comments and References	<ul style="list-style-type: none"> ✓ Acceptable ✗ Not acceptable 😞 Only acceptable if the first-choice species or variety is not available 📘 No data available 			*Suitable for kraft pulp ¹ refer Part 2 Silviculture Chapter 2 ² refer Part 1 Forest management Chapter 3		

Jan 2022

4.3 Pinus taeda

Summary	<i>Pinus taeda</i> , commonly known as loblolly pine, is native to North America. Optimally, <i>P. taeda</i> requires a MAP > 950 mm, although it can be grown with lower rainfall where temperatures are also relatively lower (Smith, 1998). The species is, however, sensitive to drought. <i>Pinus taeda</i> requires mean annual temperatures ≥ 13 degree Celsius, with July (mid-winter) mean temperatures > 8 degree Celsius, but with January (midsummer) means < 26 degree Celsius (Smith, 1998). While resistant to hail, <i>P. taeda</i> is very prone to snow damage. Moderate to high tolerance to resistant to <i>Diplodia sapinea</i> (canker/die back) and <i>Fusarium circinatum</i> (pitch canker fungus). Has been affected by <i>Sirex noctilio</i> in some areas of South Africa.					
Province	KwaZulu-Natal			Mpumalanga		
	✓			✓		
MASL range (m)	100 - 1500			600 - 1400		
MAP range (mm)	950+					
MAT range (°C)	15 – 17					
Soil depth (cm)	75+					
Silvicultural Zones¹	ST	WTW	WTC	CTW	CTC	
	✗	✓	✓	✓	✗	
Site Quality²	SQ1	SQ2	SQ3	SQ4	SQ5	
	n/a	✓	✓	✓	✓	
Abiotic tolerance	Frost	Snow	Wind	Drought	Water-logged soils	
	Moderate	Moderate	Moderate	Low	Low	
Pest, Disease and Fire tolerance	<i>Fusarium circinatum</i>	<i>Sirex noctilio</i>	<i>Diplodia sapinea</i>	<i>Rhizina undulata</i>	Fire	Animal damage
	Moderate	Low	Moderate	Moderate	Low	High
Other characteristics of commercial value	Coppice potential	Stem defects and poor form	Bark stripping	Flowering		
	n/a	Low	n/a	Age until flowering	Annual flowering times	
				8 years (in plantation espacement)	July	
Wood quality	Density		Pulp yield		Wood pulpability*	
	Moderate		Moderate - High		High	
Markets/Uses	Dissolving pulp	Kraft pulp	Saw timber	Newsprint	Other	
	✗	✓	✓	✗	Veneer	

4.4 *Pinus patula* x *Pinus tecunumanii* Low elevation (PPTL)

Summary	Inter-specific <i>Pinus</i> hybrids have been developed for any one of three reasons: to combine desired traits of two species; to exploit hybrid vigour (heterosis); or to increase the adaptability of a pine species to areas which are marginal for the parent species. The PPTL hybrid combines the good growth and wood property traits of <i>P. patula</i> with the disease tolerance and good growth and wood properties of <i>P. tecunumanii</i> LE and is substantially more tolerant to <i>Fusarium circinatum</i> . The wood properties of PPTL are also very favourably for kraft pulp, with uniform wood density. The PPTL hybrid is susceptible to cold damage and care must be taken to avoid sites with high frost risk.					
Province	KwaZulu-Natal			Mpumalanga		
	✓			✓		
MASL range (m)	1000≥			1100 - 1600		
MAP range (mm)	850+					
MAT range (°C)	15 - 17					
Soil depth (cm)	30 on saprolite, 60+ on rocky soils					
Silvicultural Zones¹	ST	WTW	WTC	CTW	CTC	
	X	✓	✓	✓	✓	
Site Quality²	SQ1	SQ2	SQ3	SQ4	SQ5	
	n/a	✓	✓	✓	✓	
Abiotic tolerance	Frost	Snow	Wind	Drought	Water-logged soils	
	Low	Low	Moderate	Moderate	Low	
Pest, Disease and Fire tolerance	<i>Fusarium circinatum</i>	<i>Sirex noctilio</i>	<i>Diplodia sapinea</i>	<i>Rhizina undulata</i>	Fire	Animal damage
	High				Low	Moderate
Other characteristics of commercial value	Coppice potential	Stem defects and poor form	Bark stripping	Flowering		
				Age until flowering	Annual flowering times	
	n/a	Low	n/a	5 years (in plantation espacement)	August to September	
Wood quality	Density		Pulp yield		Wood pulpability*	
	Moderate		Moderate-High		High	
Markets/Uses	Dissolving pulp	Kraft pulp	Saw timber	Newsprint	Other	
	X	✓	✓	✓	Veneer	

Comments and References	✓ Acceptable ✗ Not acceptable 😞 Only acceptable if the first-choice species or variety is not available ℹ No data available	*Suitable for kraft pulp ¹ refer Part 2 Silviculture Chapter 2 ² refer Part 1 Forest management Chapter 3 Jan 2022
--------------------------------	--	---

4.5 *Pinus patula* x *Pinus tecunumanii* High elevation (PPTH)

Summary	Inter-specific <i>Pinus</i> hybrids have been developed for any one of three reasons: to combine desired traits of two species; to exploit hybrid vigour (heterosis); or to increase the adaptability of a pine species to areas which are marginal for the parent species. The PPTH hybrid combines the good growth and wood property traits of <i>P. patula</i> with the disease tolerance and good growth and wood properties of <i>P. tecunumanii</i> LE and is substantially more tolerant to <i>Fusarium circinatum</i> . The wood properties of PPTH are also very favourably for kraft pulp, with uniform wood density. The PPTH hybrid is less susceptible to cold damage than the PPTL hybrid but is less tolerant than pure <i>P. patula</i> .					
Province	KwaZulu-Natal		Mpumalanga			
	✓		✓			
MASL range (m)	1200≥		1400 - 1750			
MAP range (mm)	800+					
MAT range (°C)	13 – 15					
Soil depth (cm)	30 on saprolite, 60+ on rocky soils					
Silvicultural Zones¹	ST	WTW	WTC	CTW	CTC	
	✗	✗	✓	✓	✓	
Site Quality²	SQ1	SQ2	SQ3	SQ4	SQ5	
	n/a	✓	✓	✓	✓	
Abiotic tolerance	Frost	Snow	Wind	Drought	Water-logged soils	
	Moderate	Moderate	Moderate	Moderate	Low	
Pest, Disease and Fire tolerance	<i>Fusarium circinatum</i>	<i>Sirex noctilio</i>	<i>Diplodia sapinea</i>	<i>Rhizina undulata</i>	Fire	Animal damage
	High	i	i	i	Low	High
Other characteristics of commercial value	Coppice potential	Stem defects and poor form	Bark stripping	Flowering		
	n/a	Low	n/a	Age until flowering	Annual flowering times	
				5 years (in plantation espacement)	August to September	
Wood quality	Density		Pulp yield		Wood pulpability*	
	Moderate		Moderate-High		High	
Markets/Uses	Dissolving pulp	Kraft pulp	Saw timber	Newsprint	Other	
	✗	✓	✓	✓	Veneer	
Comments and References	✓ Acceptable ✗ Not acceptable 😞 Only acceptable if the first-choice species or variety is not available i No data available		*Suitable for kraft pulp ¹ refer Part 2 Silviculture Chapter 2 ² refer Part 1 Forest management Chapter 3			
	Jan 2022					

4.6 *Pinus elliottii* x *Pinus caribaea* var. *hondurensis* (PECH)

Summary	Inter-specific <i>Pinus</i> hybrids have been developed for any one of three reasons: to combine desired traits of two species; to exploit hybrid vigour (heterosis); or to increase the adaptability of a pine species to areas which are marginal for the parent species. The <i>P. elliottii</i> x <i>P. caribaea</i> hybrid combines good form with good growth and is 65% more productive than pure <i>P. elliottii</i> . The wood properties are acceptable for Kraft pulp. Tolerant to <i>Fusarium circinatum</i> and <i>Diplodia sapinea</i> .					
Province	KwaZulu-Natal			Mpumalanga		
	✓			✓		
MASL range (m)	<1200			<1200		
MAP range (mm)	700–950					
MAT range (°C)	> 18					
Soil depth (cm)	35+					
Silvicultural Zones¹	ST	WTW	WTC	CTW	CTC	
	✗	✓	✓	✗	✗	
Site Quality²	SQ1	SQ2	SQ3	SQ4	SQ5	
	✓	✓	✓	✓	✓	
Abiotic tolerance	Frost	Snow	Wind	Drought	Water-logged soils	
	Low	Moderate	Moderate	Moderate-High	Low	
Pest, Disease and Fire tolerance	<i>Fusarium circinatum</i>	<i>Sirex noctilio</i>	<i>Diplodia sapinea</i> blight	<i>Rhizina undulata</i>	Fire	Animal damage
	High		High		Moderate	High
Other characteristics of commercial value	Coppice potential	Stem defects and poor form	Bark stripping	Flowering		
				Age until flowering	Annual flowering times	
	n/a	Low	n/a	8 years (in plantation espacement)	August to September	
Wood quality	Density		Pulp yield		Wood pulpability*	
	Low-Moderate		Moderate-High		Moderate	
Markets/Uses	Dissolving pulp	Kraft pulp	Saw timber	Newsprint	Other	
	✗	✓	✓	✓	Veneer	
Comments and References	<ul style="list-style-type: none"> ✓ Acceptable ✗ Not acceptable 😞 Only acceptable if the first-choice species or variety is not available No data available 			<ul style="list-style-type: none"> *Suitable for kraft pulp ¹ refer Part 2 Silviculture Chapter 2 ² refer Part 1 Forest management Chapter 3 		
	Jan 2022					

CHAPTER 2 - SITE-GENOTYPE MATCHING

The choice of genotype (species or hybrid) is an important decision that can influence the success of a forestry enterprise. There is only one opportunity per rotation to change the crop that is grown. Changes in species/provenance, and the use of new hybrid varieties (clones) or genetically improved seed can improve yields in subsequent rotations.

The introduction of exotic forest tree species with much faster growth rates than indigenous species (for example *Pinus patula*, *P. elliottii*, *P. taeda*, *P. radiata*, *Eucalyptus grandis*, *E. nitens* and *Acacia mearnsii*) brought a major advantage to the southern African timber industry. Several lesser-known species and hybrids between some of these species are receiving increasing interest. Although single-species plantations are easy to manage and harvest, a given species will not be optimally suited everywhere due to site variability. The species planted off-site will suffer stress and cause high risk.¹

The main aim of planting the most suitable species on each site is to increase the quantity whilst simultaneously lowering the cost of timber. To achieve this, a balance must be found between maximizing yield, minimizing risk of crop loss (as the result of pests and disease; climate (e.g., frost, snow, drought, wind) and other factors (e.g., fire, theft)) whilst producing a product that is acceptable to the market (Figure 1).

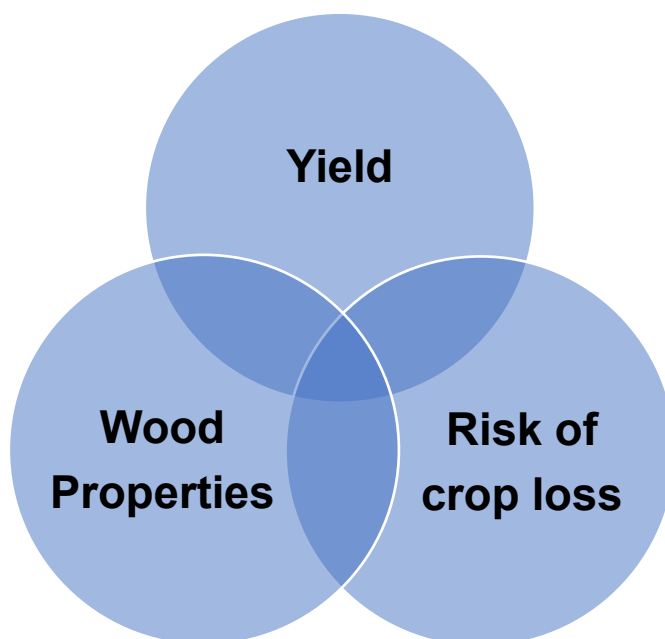

Figure 1: Site-genotype matching requires a balance between optimizing yield, minimizing the risk of crop loss, and producing a product that is accepted by the market.

The main criteria that are normally used to assess the suitability of a species on a site are climate, soil and terrain, and biotic factors. The most important climatic factor is ambient air temperature, as each genotype has a specific optimum range of physiological activity for fast and continuous growth as well as resistance to frost/snow and disease. This is normally assessed from mean annual temperature (MAT) in association with monthly maximum and minimum temperatures. Secondly, mean annual precipitation (MAP) is used to define the expected quantity of rain on a site.

Soil factors that should be considered are effective rooting depth (ERD), texture, structure, drainage, fertility, stones and lithology or geological parent material.² Topography should

also be considered. For example, planting of eucalypts on steep slopes will require more frequent and more expensive harvesting than if pines, which have a longer rotation length than eucalypts, are planted on these sites. Information on site conditions where species occur in their natural habitat and the results from site-species trials and provenance, progeny trials and block plantings are used to identify the optimum growing conditions for each genotype.

In Sappi the diverse range of sites is stratified in terms of silvicultural zone (temperature) and site quality. Three main silviculture zones have been identified based on temperature and the degree of frost:

1. The **subtropical** zone which is characterised by a mean annual temperature (MAT) of 20.1 - 22°C with virtually no frost.
2. The **warm temperate** zone has a MAT of 16.1 - 20°C with light frosts.
3. The **cool temperate** zone has a MAT of 13.1-16°C with moderate to severe frosts.³

The silvicultural zones also correspond to snow risk in KwaZulu-Natal. By applying the ranking of species' snow tolerance from most susceptible to most tolerant to snow (*E. dunnii* > *E. macarthurii* > *E. smithii* > *E. grandis* x *E. nitens*)⁴ to the climatic zone of each compartment, the most appropriate species to minimize snow damage can be selected.

Site quality refers to the tree growth capability of a site and is a rating of the productivity of a site in terms of timber production. The production capability of a site is a function of the climatic and edaphic (soil) factors that characterize the site. Site quality classes form a broad classification of site productivity – refer to the chapter on Growth and Yield (Part 1 - Chapter 3). Sappi has five site quality classes that cover a range of sites from the poorest (SQV) to the most productive (SQI).⁵

Drought risk has been positively correlated with site quality as drought mortality predominantly occurs on low site qualities which are characterized by low precipitation and shallow soils. The most recent recommendations for hardwoods and softwoods' deployment per silvicultural zone and site quality class are provided in Tables 1 and 2, respectively.

It is also important to consider additional information based on local knowledge and common sense. For example, by evaluating the position of a compartment in the landscape the likelihood of frost pockets can be estimated. A frost risk map has been developed by Sappi to assist foresters to identify areas where frost risk will be high. Furthermore, risks in terms of wind damage, fire, risk of cattle or animal damage and theft must be evaluated. Timber theft in certain areas might favour the planting of a pine species as opposed to a eucalypt species.

As mentioned in the introduction, risk can be reduced by planting a diverse range of species. Monoculture planting poses a risk in terms of disease and fire, which are increased when single species or varieties are planted. The Sappi guideline for deployment recommends that no more than 20% of a region should be planted to one specific variety (clone) and that the varieties should be genetically unrelated.

Site-genotype matching is a dynamic process. Although climate change will influence site-genotype matching, the changes will be relatively slow and can be accommodated over rotations. However, the appearance of new pests and diseases and constant changes in market requirements have a much greater short-term influence on site-genotype matching.

MAT (°C)	Silviculture Zone	Frost Risk	Site Quality				
			SQI	SQII	SQIII	SQIV	SQV
21	Sub-tropical	None	<i>Eucalyptus grandis</i> x <i>E. urophylla</i> (GU)				
20		Low					
19	Warm Temperature (WT)	None	<i>E. dunnii</i> GU <i>E. grandis</i> *	<i>E. dunnii</i>			
18		Low					
17		Moderate					
16		High					
16	Warm Temperature (WT)	None	<i>E. grandis</i> x <i>E. nitens</i> (GN) † <i>E. smithii</i> ~ <i>E. dunnii</i>	GN † <i>E. dunnii</i>	<i>E. dunnii</i> GN †		
		Low					
		Moderate	<i>E. benthamii</i> ** GN † <i>E. badjensis</i>		<i>E. macarthurii</i> ** GN †		
		High					
15	Cool Temperature (CT)	None	GN <i>E. smithii</i> ~ <i>E. dunnii</i>		<i>E. dunnii</i> GN		
		Low					
		Moderate	<i>E. benthamii</i> ** GN <i>E. badjensis</i>		<i>E. macarthurii</i> ** GN <i>E. bad</i>		
		High					
14	Cool Temperature (CT)	None	<i>E. grandis</i> x <i>E. nitens</i> (GN) <i>E. badjensis</i>				
		Low					
		Moderate					
13	Cool Temperature (CT)	High	<i>E. benthamii</i> ** GN <i>E. badjensis</i>		<i>E. macarthurii</i> ^** GN <i>E. bad</i>		

Sappi Frost Classes: No risk = 1; low risk = 2, 3; moderate risk = 4, 5, 6; high risk = 7, 8, 9

* *E. grandis* is planted in as an alternative to *E. dunnii* to reduce the risk associated with the *E. dunnii* monoculture. In Mpumalanga, the recommendation has been reverted to *E. dunnii* on these sites due to *Leptocybe*.

† *E. grandis* x *E. nitens* (GN) not to be planted <1100 m due to *Leptocybe* risk.

~ *E. smithii* only to be planted in KwaZulu-Natal

** *E. benthamii* and *E. macarthurii* not to be planted on areas where snowfall is likely in KZN

^ Softwood (e.g. *P. patula*) should preferably be planted on these sites

E. benthamii and *E. badjensis* only approved by Saiccor not Ngodwana. Testing for Ngodwana in process. CEO approval to deploy *E. benthamii* in Mpumalanga as it is the most suitable replacement for *E. nitens* and to plant test blocks of *E. badjensis*.

Table 1: Hardwood site-genotype matching

MAT (°C)	Silviculture Zone	Frost Risk	Site Quality					
			SQI	SQII	SQIII	SQIV	SQV	
19	Warm Temperature (WT)	WT Warm	None	<i>Pinus elliottii</i> x <i>P. caribaea</i> (var. hondurensis) (PECH)				
18			Low					
17			Moderate	<i>Pinus taeda</i>			<i>Pinus elliottii</i>	
			High					
16		WT Cool	None	<i>P. patula</i> x <i>P. tecunumanii</i> (Low Elevation) (PPTL)				
			Low					
			Moderate					
			High	<i>P. taeda</i>	<i>P. tae</i> <i>P. pat</i>	<i>P. patula</i> *		
15	CT Warm	None	<i>P. patula</i> x <i>P. tecunumanii</i> (Low Elevation) (PPTL)					
		Low						
		Moderate	<i>P. patula</i> x <i>P. tecunumanii</i> (High Elevation) (PPTH)** <i>P. patula</i> *					
		High	PPTH** <i>P. taeda</i> <i>P. patula</i>	PPTH <i>P. pat</i>	PPTH** <i>P. patula</i> *			
	14	CT Cool	None	<i>P. patula</i> x <i>P. tecunumanii</i> (Low Elevation) (PPTL)				
			Low					
			Moderate	<i>P. patula</i> x <i>P. tecunumanii</i> (High Elevation) (PPTH)** <i>P. patula</i> *				
			High					
13		High						

Sappi Frost Classes: No risk = 1; low risk = 2, 3; moderate risk = 4, 5, 6; high risk = 7, 8, 9
 On soft plinthic sub-soils (wet soils) *P. elliottii* should be planted
 * *Pinus greggii* var. *greggii* (Northern *greggii*) and *P. greggii* var. *australis* (Southern *greggii*) are no longer planted due to susceptibility to *Fusarium circinatum*
 ** At present only PPTL is being produced, PPTH is indicated for future deployment

Table 2: Softwood site-genotype matching

References

¹ Theron JM (2000) Site requirements and species matching. Section 3.5 in Owen, D., (ed.) South African Forestry Handbook 2000. South African Institute of Forestry, Pretoria.
² Herbert M (2000) Eucalypt and wattle species. Section 3.5 in Owen, D., (ed.) South African Forestry Handbook 2000. South African Institute of Forestry, Pretoria.
³ Poynton RJ (1977) Tree planting in Southern Africa. Vol. 1. The pines. Department of Forestry, Pretoria.
⁴ Pallett RN (1998): Assessing snow risk for eucalypt forestry crops in the cool temperate hardwood zone in KwaZulu-Natal. Research Document 4/98. Sappi Forests Research, Tweedie.
⁵ Pallett RN (2001) Site Quality Classification based on Forest Land Types for Sappi Landholdings. Sappi Forests Research Document 01/2001.

CHAPTER 3 - SEEDLINGS AND CUTTINGS	Page
1 Introduction	37
2 Seedling and cutting orders	37
3 Quality	38
4 Transport	38
5 Transit nurseries	39
5.1 Where to store plants temporarily	39
5.2 Watering	39
5.3 Diseases in holding nurseries	40

1 Introduction

The planting of seedlings or cuttings is the first step in establishing a plantation. Research and extensive experience have resulted in the supply of good quality genetic material for commercial plantation forestry.

This chapter includes three tables which show the Sappi Plant Quality Index (PQI) specifications by species. These are guidelines to determine the quality of seedlings and cuttings.

2 Seedlings and cuttings orders

Plants need to be ordered with sufficient lead-time to ensure that the nursery will be able to produce them. The ordering lead-time (Table 1) shows the minimum length of time required for plant production when the nursery produces the plants through the winter months. A shorter period is required when part of the complete production takes place through summer. These would generally be for plants required in spring or early summer.

Plant orders and changes to orders must be done on the Nursery Management System (NMS) and confirmation of these will be provided to the relevant parties.

Species	Lead-time required to produce plants, in months *	Order for October needs to be placed by
<i>P. greggii</i> (northern)	10	January
<i>P. greggii</i> (southern) and <i>P. patula</i>	9	February
<i>P. elliotii</i> , <i>P. taeda</i> , <i>A. mearnsii</i> , <i>E. grandis</i> , <i>E. smithii</i> , <i>E. macarthurii</i> and <i>E. nitens</i>	8	March
<i>E. dunnii</i>	7	April
Pine cuttings	10	January
Eucalypt cuttings	4	June

*These figures are based on the winter window for the nursery to produce plants. Shorter periods during other times of the year can be negotiated.

Table 1: Ordering lead times.

It is important that careful planning is done before ordering plants from the nursery. The plants have a two-month window in which they remain within quality specifications, after which they will be discarded. For example, if one orders plants for October, they can be picked up in October (preferably), or during November. If they are not taken by November, the nursery will have to discard them. The plants will have to be produced again, and the lead-time will apply (Tables 2 to 5) before the plants will be ready. Discarded plants will be charged to customers if no prior cancellation with the relevant nursery.

3. Quality

Sappi has developed a system called the Plant Quality Index (PQI), whereby the nursery measures certain parameters in randomly chosen plants and allocate scores. The minimum score a plant batch can attain is a PQI of 60, and the maximum is 100 (see Tables 2 to 5 and Figures 1 to 5).

If a batch of plants does not attain the minimum score of 60, or if there is too much variability in the batch (i.e., variations/differences amongst the plants of more than 10%), they will either be discarded, or grown for longer until they comply. Plants older than the specified age have been found to perform poorly when planted, therefore it is important that plants are taken on time. Plants showing any signs of disease will not be dispatched.

4. Transport

The best time to collect plants is early in the morning or late in the afternoon when it is cooler.

A rack type system is recommended to transport plants, and although costly, results in fewer losses and less blanking. A specialised trailer such as that in Photo 1 can easily be constructed after consultation with your local nursery, considering the relevant seedling tray and seedling sizes. This will ensure seedlings and cuttings are transported in the most efficient way to enhance survival and growth.



Photo 1: Seedling trailer capable of transporting \pm 10,000 seedlings in Sappi 49 trays.¹

sappi

The height between the racks should be more than 35 cm, as the tray is 10 cm deep, and the maximum height of plants (except wattle) is 25 cm. It is recommended that shade cloth be used to cover the plants, to avoid excessive exposure to the sun or wind during transport.

Various tray types are used to propagate plants. S49 trays are used to produce seedlings, and either Unigro or the newly implemented Ellepot trays are used to produce cuttings. The dimensions of the Ellepot tray are the same as the Unigro so no alternations to the transport system currently in use will be necessary.

All trays are to be returned to the nursery of origin by 30 June (summer plantings) and 20 September (winter plantings) of each year.

5. Transit nurseries

Plants collected from the nursery are in peak condition for planting. Holding plants is strongly discouraged, as delays in planting can impact on plant quality, survival, and eventual growth.

- Plants should be planted **within one week** after collection from the nursery.
- Plants dispatched in **liners** should be planted immediately (the day they are taken or the following day at the latest). Plants dispatched in liners must **not** be transplanted into trays, for planting later.
- The plants are fertilised before dispatch and can become oversized when planting is delayed.
- Holding nurseries are often ill equipped to monitor and protect plants from diseases, as opposed to the commercial nurseries.
- If a transit nursery is unavoidable, the following is important:
 - where to store plants temporarily.
 - watering.
 - diseases.

5.1 Where to store plants temporarily

Not in the best shade! The plants are grown under 200-micron plastic tunnels at the nursery, and the plants are hardened off to survive full light conditions. By holding them in full shade, this hardening is reversed. The plants will be in full sunlight once planted and may be scorched. Besides, shady areas often remain damp, which favours disease.

Plants stored in full sun need regular watering. Select a well-drained area.

Do not place trays straight onto the ground but raise them, as air prunes the roots. Watering may leave large puddles on the ground, which can “drown” the sensitive root tips if trays are not raised. It could also lead to diseases spreading from one area to another. Preferably, the trays should be raised sufficiently high to keep them out of the splash zone. Trays can be raised on wired table structures, poles, or bricks.

5.2 Watering

This is critical to the survival of the plants. Water the plants well after arrival, even if it's late afternoon or evening. From the first day of holding, a strict watering regime needs to be adhered to. Consider the following:

- Overcast and rainy weather: no need to water - only if the plant tips are drooping.
- Water first thing in the morning:
 - Do not supply too much water but ensure the root plugs are saturated with water. Water running from the bottom of the trays does not imply the entire plug is wet - pull a plant from the tray and test how wet the plug is. The basic rule is to keep the leaves as dry as possible but the medium wet, especially overnight.

sappi

- If a sprinkler system is used, alter its position every 15-20 minutes to ensure adequate cover.
- Ensure the edge plants are sufficiently wet. These are the first ones to dry out as they are exposed to more light and air movement. If the edge plants are rather dry, but the middle ones are wet (e.g., on an overcast day) water the edges only. This also applies when checking the plants at midday. If the edge plants are drooping, but the middle ones still have moisture in their plugs, just water the edge ones.
- Re-watering: check daily if the root plugs are dry. Some planting medium and tray types dry out quicker and therefore daily checks are required. However, re-water:
 - Before planting out, thoroughly.
 - When plant tips are drooping.
 - In very hot conditions (30°C plus), water daily (before midday, but preferably first thing in the morning).

5.3 Diseases in holding nurseries

The most common disease is *Botrytis* which looks very similar to bread mould. While chemicals can be applied to control infestations, the following will contribute:

- Good management of watering in the holding nursery (as described in 5.2).
- Ample air flow through the leaves of plants. Consider the following:
 - Spread the trays out (beware of outer plants drying out).
 - Soft (unhardened) plants are more susceptible to disease, as their leaves grow large and soft, resulting in a dense leaf mass that impedes air flow and remain damp. The test for hardness is plants that feel hard to the touch. Plants easily manipulated are soft.

Trays with dead & dying plants: separate these trays and remove the infected plants from the trays. Limit touching the healthy plants - wash hands every 10-15 minutes to remove any accumulated spores. Burn or discard the infected plants from the holding nursery.



		<i>E. grandis</i>			<i>E. dunnii</i>			<i>E. smithii</i>			<i>E. nitens</i>		
		Specifications	Min. score	Max. score	Specifications	Min. score	Max. score	Specifications	Min. score	Max. score	Specifications	Min. score	Max. score
AGE	Winter grown	7-8 months	5	10	6-7 months	5	10	7-8 months	15	30	7-8 months	10	20
	Summer grown	6-7 months			6-7 months			6-7 months					
PLANT SIZE	Height Range	10cm - 25cm	5	20	10cm - 25cm	5	10	10cm - 25cm	5	10	10cm - 25cm	5	10
	Topping allowed ?	Yes			Yes			No			No		
ROOT PLUG	Ht:RCD Ratio	<90 - 130	5	10	<80 - 100	5	20	<120 - 160	5	10	<80 - 100	10	20
	Plug Integrity	Root plug fully colonised with brown:white (30:70) root tips > 2/3 of plug. Not root bound.	10	20	Root plug fully colonised with brown:white (30:70) root tips > 2/3 of plug. Not root bound.	10	20	Root plug fully colonised with brown:white (30:70) root tips > 2/3 of plug. Not root bound.	10	20	Root plug fully colonised with brown:white (30:70) root tips > 2/3 of plug. Not root bound.	10	20
PLANT HEALTH	Root Spiralling	No roots spiralling or spiralling < 180° around root plug	0	10	No roots spiralling or spiralling < 180° around root plug	0	10	No roots spiralling or spiralling < 180° around root plug	0	10	No roots spiralling or spiralling < 180° around root plug	0	10
	Leaf colour	Green or green red, not very red or yellow	10	15	Green to deep green	10	15	Light grey/green to dark grey/green	5	10	Dark blue/green or light blue/green to slightly redish/blue/green	5	10
	No sign of disease	Yes	FAIL	15	Yes	FAIL	15	Yes	FAIL	10	Yes	FAIL	10
			60	100		60	100		60	100		60	100

NB. The minimum scores listed above do not add up to 60. This is an indication that if the seedlings scored as they have above, they would fail, and be unable to be dispatched. Root spiralling and disease are non-negotiables ie if greater than 10% of the seedlings measured in any batch fail a 0 score will be obtained. If any plants are diseased the batch will fail and will not be dispatched. NB These specifications refer to plants raised in Sappi 49 trays only.

Table 2: PQI specifications for *E. grandis*, *E. dunnii*, *E. smithii* and *E. nitens* seedlings.

		<i>A. mearnsii</i> (Wattle)			<i>Northern P. greggii</i>			<i>P. patula / P. greggii</i> (Southern)			<i>P. elliottii / P. taeda</i>		
		Specifications	Min. score	Max. score	Specifications	Min. score	Max. score	Specifications	Min. score	Max. score	Specifications	Min. score	Max. score
AGE	Winter grown	7-8 months	5	10	10-11 months	10	20	8-9 months	10	20	7-8 months	10	20
	Summer grown	6-7 months	5	10	9-10 months	10	20	7-8 months	10	20	6-7 months	10	20
PLANT SIZE	Height Range	15cm - 40cm	10	20	10cm - 20cm	5	10	10cm - 20cm	5	10	10cm - 25cm	5	10
	Topping allowed ?	Yes			No	FAIL		No	FAIL		No	FAIL	
ROOT PLUG	Ht:RCD Ratio	<100 - 120	5	20	<80 - 100	5	20	<80 - 100	5	20	<90 - 110	5	20
	Plug Integrity	Colonised with white root tips along length of plug. Not root bound with brown root tips or white tips in only bottom 1/3	5	10	Colonised with white:brown (50:50) root tips > 2/3 of plug. Not root bound with brown root tips or white tips in only bottom 1/3	5	10	Colonised with white:brown (50:50) root tips > 2/3 of plug. Not root bound with brown root tips or white tips in only bottom 1/3	5	10	Colonised with white:brown (50:50) root tips > 2/3 of plug. Not root bound with brown root tips or white tips in only bottom 1/3	5	10
	Root Spiralling	No roots spiralling or spiralling < 180° around root plug	0	10	No roots spiralling or spiralling < 180° around root plug	0	10	No roots spiralling or spiralling < 180° around root plug	0	10	No roots spiralling or spiralling < 180° around root plug	0	10
	J- roots (*)				Less than 8% seedlings with 'J-root' scores of 4 and 5	FAIL	10	Less than 8% seedlings with 'J-root' scores of 4 and 5	FAIL	10	Less than 8% seedlings with 'J-root' scores of 4 and 5	FAIL	10
PLANT HEALTH	Rhizobium nodules / Mycorrhizae present	Presence of Rhizobium nodules on roots	0	10	Grey to white fungus on root plug; bifurcating root tips	0	5	Grey to white fungus on root plug; bifurcating root tips	0	5	Grey to white fungus on root plug; bifurcating root tips	0	5
	Leaf colour	Green to deep green	5	10	Deep green to green to light green	5	10	Deep green to green to light green	5	10	Green purple to deep green to slight yellow green	5	10
	No sign of disease	Yes	FAIL	10	Yes	FAIL	5	Yes	FAIL	5	Yes	FAIL	5
			60	100		60	100		60	100		60	100

NB. The minimum scores listed above do not add up to 60. This is an indication that if the seedlings scored as they have above, they would fail, and be unable to be dispatched.

Root spiralling, a fungal symbiosis and disease are non-negotiables ie if greater than 10% of seedlings measured fail a 0 score is obtained.

If any plants are diseased the batch will fail and will not be dispatched. NB These specifications refer to plants raised in Sappi 49 trays only.

* Technical note 8. Root deformities in seedlings (Jan 2002)

Table 3: PQI specifications for *A. mearnsii*, *Northern P. greggii*, *Southern P. patula/P. greggii* and *P. elliottii/P. patula* seedlings.

Eucalyptus Cuttings

		Unigro 128			Unigro 98		
		Specifications	Min. Score	Max. Score	Specifications	Min. Score	Max. Score
Age	Summer	3-4 Months	5	10	4-5 Months	5	10
	Winter	3-4 Months			4-5 Months		
Plant Specs	Height	15cm - 30cm	5	10	15cm - 30cm	5	10
	Depth	2cm - 3cm	0	5	2cm - 3cm	0	5
	Position	Center	0	5	Center	0	5
Root Plug	Plug Integrity	Root plug partially colonised (50% of medium falls off) or root plug colonised but not root bound.	15	30	Root plug not colonised, partially colonised, colonised but not rootbound, rootbound	15	30
	Root Tips	Percentage white root tips	5	15	Percentage white root tips	5	15
Plant Health	Leaf Colour	Acceptable Unacceptable	0	10	Acceptable Unacceptable	0	10
	Disease	No signs	FAIL	10	No signs	FAIL	10
			60	100		60	100

NB. The minimum scores listed above do not add up to 60. This is an indication that if the Cuttings scored as they have above, they would fail, and be unable to be dispatched. Disease is a non-negotiable, ie no plants should show signs of disease. If signs of disease are evident then the batch will fail.

Table 4: PQI specifications for *Eucalyptus* cuttings.

		<i>PECH Cuttings</i>		
		Specifications	Min. score	Max. score
AGE	Winter grown	241 - 330 days	5	10
	Summer grown	211 - 300 days	5	10
PLANT SIZE	Height Range (cm)	10 - 15	5	15
	Stem D (mm)	2.5 - 3.5	10	15
ROOT PLUG	Plug Integrity	Partially Colonised or colonised but not root bound	10	20
	Root Tips	<25% spread of white roots along length of plug, 25 - 50% Intermediate spread of roots along length of plug, >50% Good spread of white roots along length of plug.	0	20
PLANT HEALTH	Weeds	Yes/No	0	5
	Leaf colour	Yellow/Brown, Yellow/Green, Deep Green	0	10
	No sign of disease	Yes/No	FAIL	5
			60	100

NB. The minimum scores listed above do not add up to 60. This is an indication that if the Cuttings scored as they have above, they would fail, and be unable to be dispatched. No cuttings should show signs of disease. Up to 10% of plants can score zero for root plug for plants produced in Unigro 98 trays.

Table 5: PQI specifications for *PECH (Pinus elliottii x caribaea var hondurensis)* cuttings.

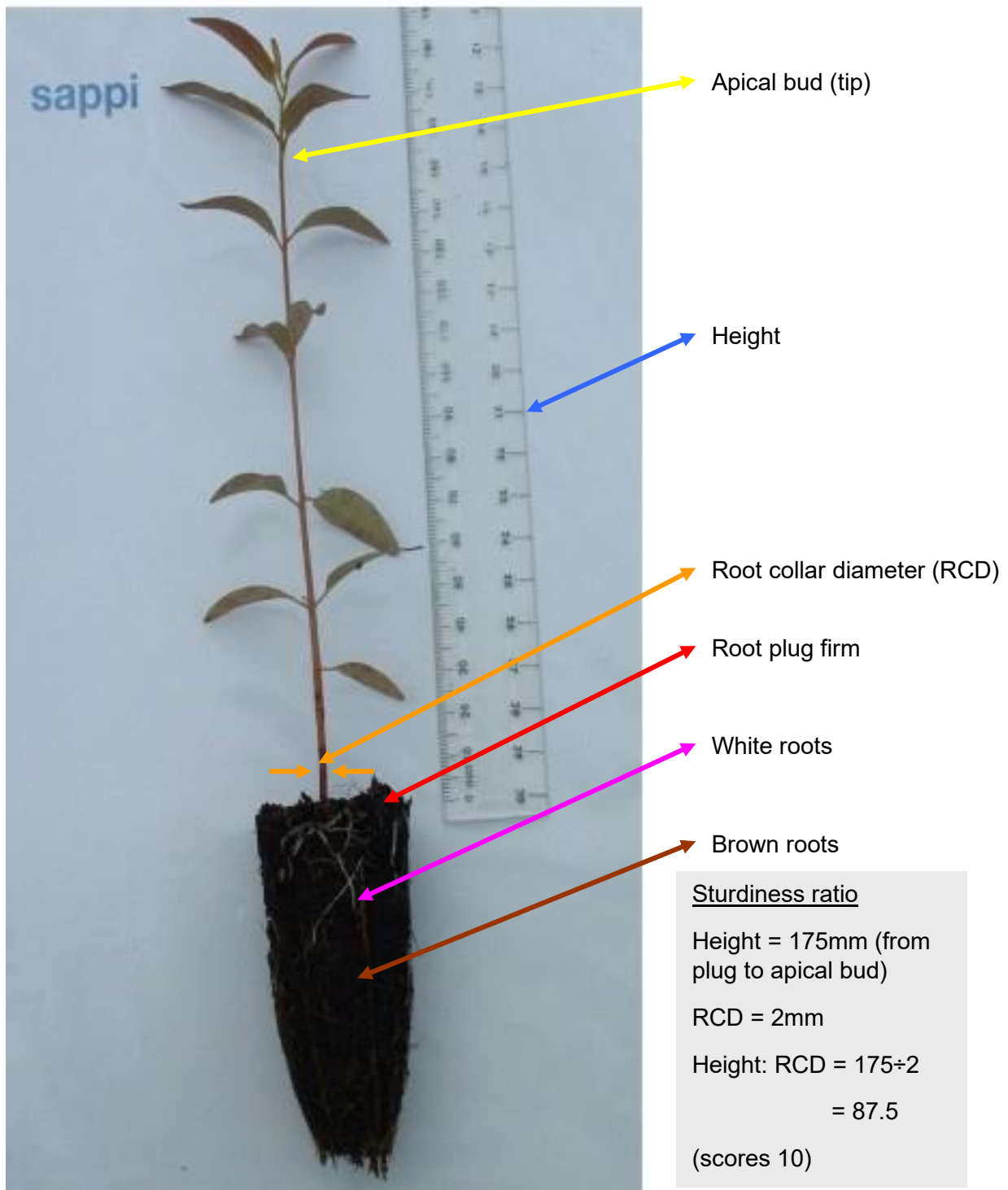

Figure 1: *E. grandis* seedling – representative of a typical *Eucalyptus* seedling.

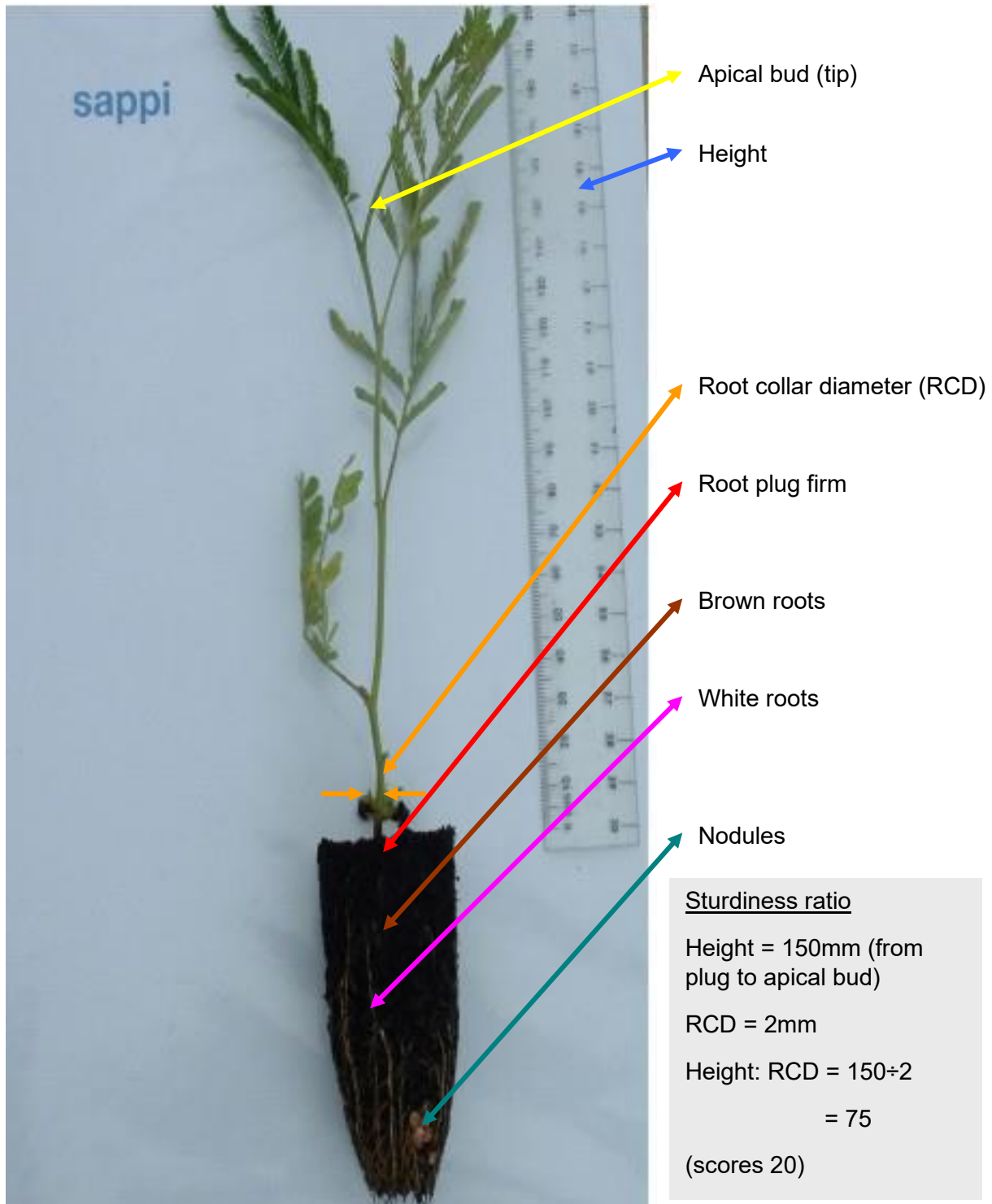

Figure 2: *A. mearnsii* (black wattle) seedling.

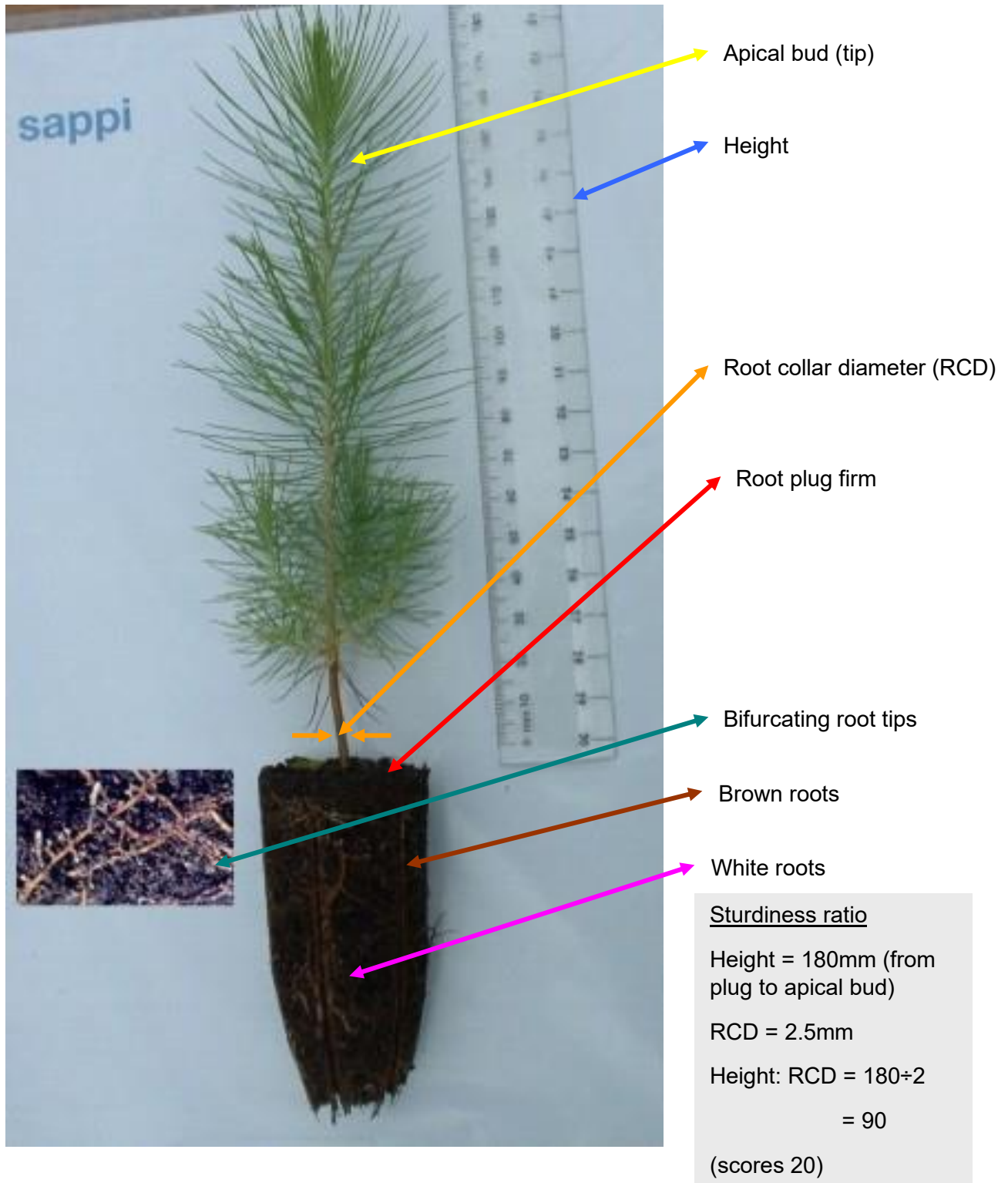

Figure 3: *P. patula* seedling – representative of a typical *Pinus* seedling.

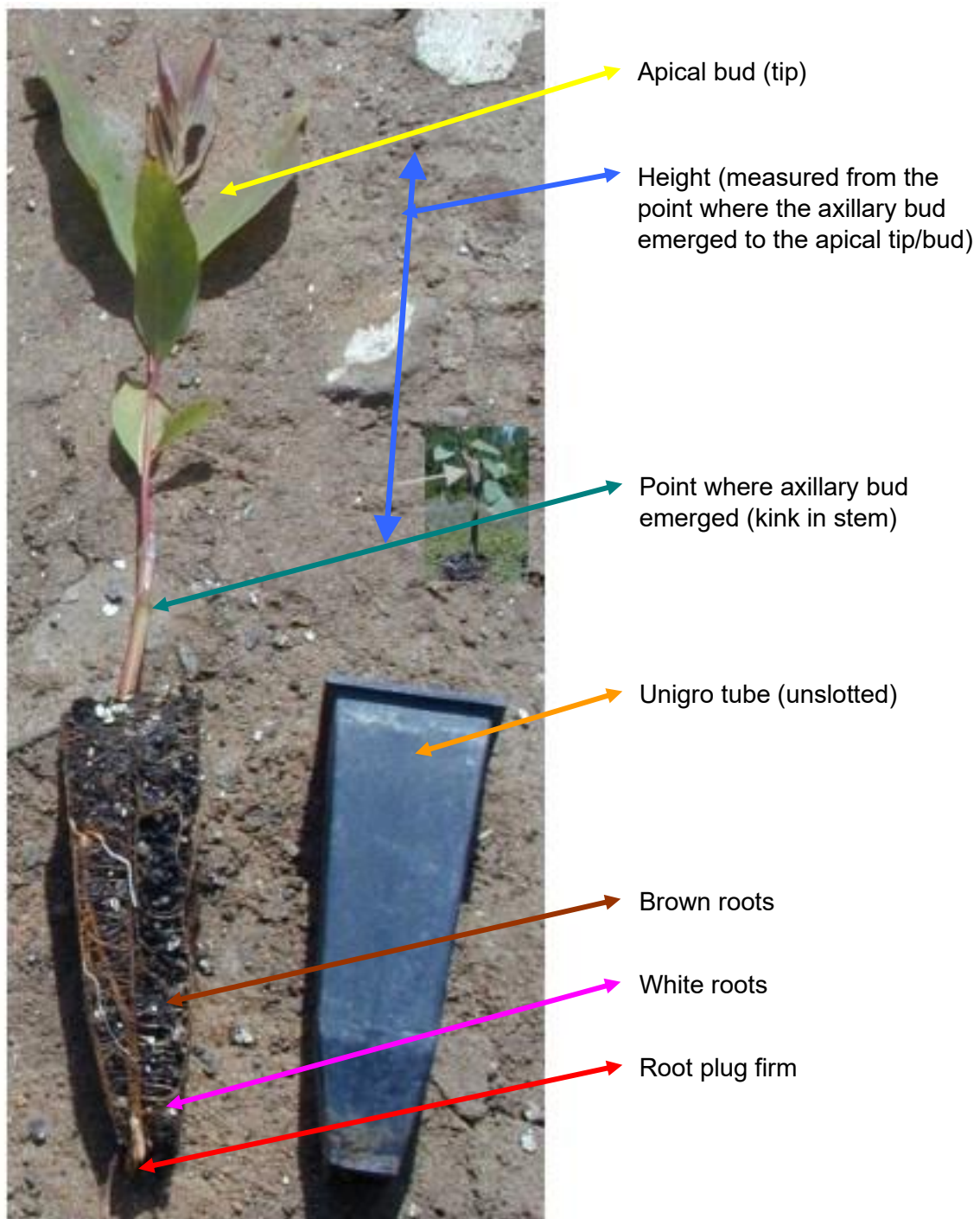

Figure 4: *Eucalyptus* cutting (in this case A380, a GU or *E. grandis* x *urophylla*).

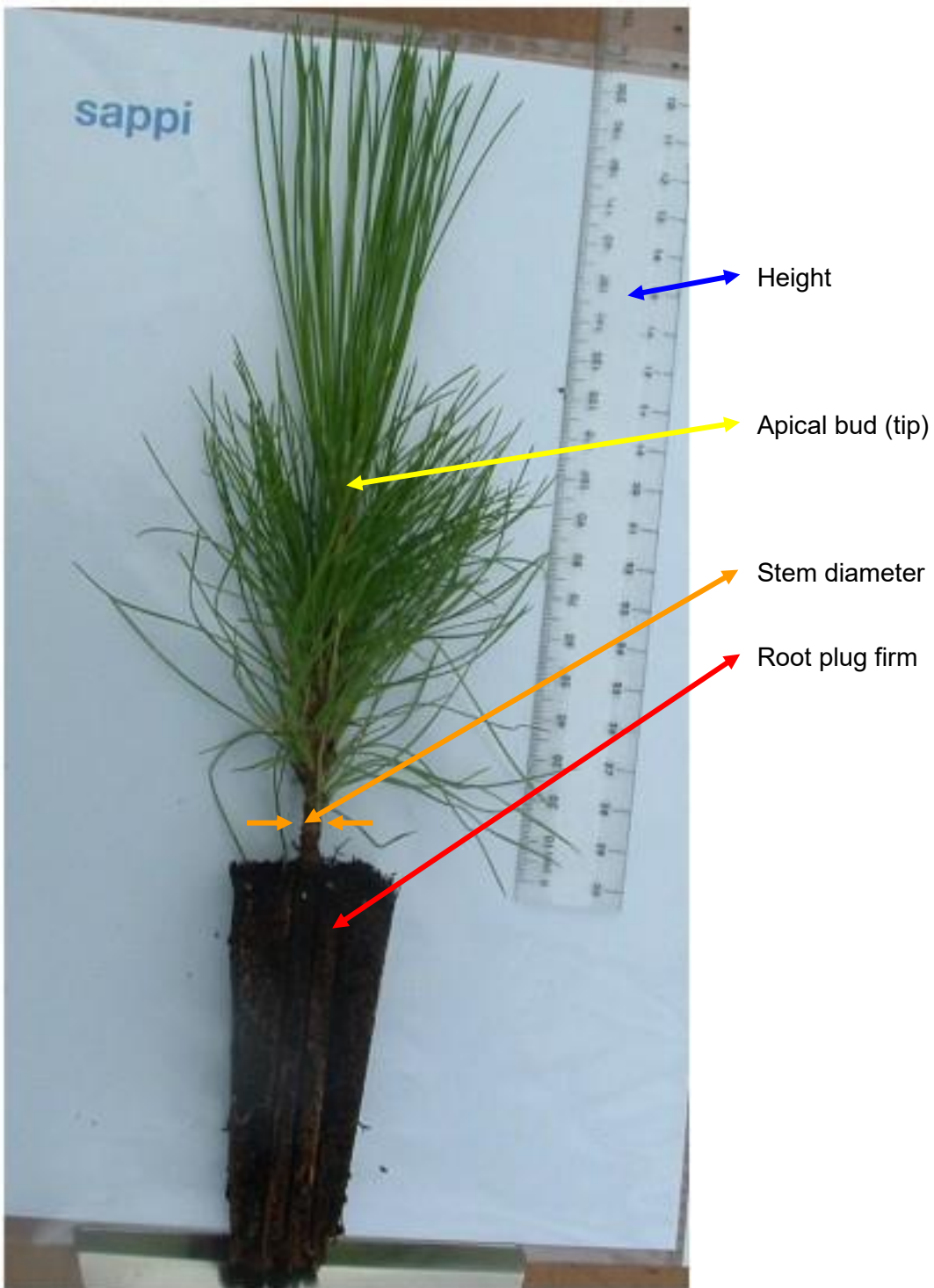

Figure 5: PECH cutting (*Pinus elliottii x caribaea var hondurensis*).

¹ Photos by J. Ballantyne.

CHAPTER 4 - LAND CLEARING	Page
1. Managing slash from previous felling operations	50
1.1 Stacking slash	50
1.2 Burning slash	50
1.3 Spreading slash	51
2. Clearing land manually by slashing	51
3. Clearing land chemically	51
3.1 Application	51
3.2 Health and safety	52
3.3 Aerial chemical spray	52
3.4 Treating stumps by frilling and applying herbicide	52
3.5 Killing stumps immediately after felling	52
4. Clearing land mechanically	53
5. Use of fire	55

Poor methods of land clearing can result in soil erosion and can significantly affect survival and growth, as well as the potential production of the site. Different methods of land clearing can be used.

1. Managing slash

Slash from previous felling operations should be managed to reduce the risk of fire and to facilitate soil preparation for re-establishment activities. In compartments where burning is not recommended due to factors such as steep slopes or erodible soils, the slash is usually spread - refer 1.3.

1.1 Stacking slash

Slash could be stacked in heaps, short rows or in small blocks but not closer than 5m to roads, open areas, or fire breaks. Keep at least 20m away from possible fire hazards such as wattle jungles and overgrown riverine areas.

The stacking of slash is a very expensive operation and not recommended, except when required to protect small areas such as Special Management Zones (SMZs) (wetland riparian areas, fire breaks or road verges) when burning a compartment.

Stacking slash to facilitate re-establishment:

- Leave 5m wide “gates” in the slash rows at 30m intervals.
- The edge of the slash row should not be stacked closer than 1m from the pegged lines to facilitate soil preparation.
- The slash load should be evenly spread in the rows.

1.2 Burning slash

Burning slash could be required in the following cases:

- to reduce the fire hazard in high-risk areas; and
- to facilitate re-establishment activities in excessive slash.

Burning prohibition periods vary between regions; enquire from the local Fire Protection Association (FPA).

Burning restrictions, as gazetted in the National Veld and Forest Fire Act (Act No. 101 of 1998), are updated annually, and should therefore be consulted to ensure that burning

operations are conducted within the parameters as set out by this Act. Refer to Chapter 9 Fire Protection.

Special requirements could be required due to SMZs in the compartment, erodible soils (sandy soils with low clay %), steep slopes (>30%) or other conditions that could result in a negative environmental impact.

Burning shall only be undertaken when approved by the local FPA. Ensure that the weather forecast on the day of the burn, as well as the day after the burn, is known, to prevent flare-ups. Notify all stakeholders of where and when burning is going to take place. Stakeholders include the local district forestry office, lookout/fire detection control room, relevant neighbours and the local FPA.

Slash burning will not be permitted until at least 50mm rain has fallen and the soil is moist enough to be squeezed into a clod. Burning should only be done within three days after rain of at least 30mm to prevent damage to the soil and humus layer.

As it is essential to have a cool burn, only one slash row or a small section of slash should be lighted at a time. Allow burning for a while to reduce heat before lighting the next section. Start burning from the top downhill, or against the wind on flat terrain.

1.3 Spreading slash

Slash should be spread evenly and cleared 5m or two tree rows away from roads, open areas, and fire breaks.

2. Clearing land manually by slashing

When clearing land manually ensure the following:

- Vegetation should be slashed to ankle height.
- Stipulate what is to be done with the brushwood.
- Brushwood shall be removed 5m from roads, open areas, and fire breaks.

3. Clearing land chemically (refer to Chapter 8 Maintenance)

Where dense seedling growth of uniform height is present, use knapsack sprayers with flat fan nozzles. Where seedlings are of uneven height (or coppice growth) use a solid cone nozzle. For medium to high density infestations, it may be necessary to slash plants for future coppice foliar spraying.

Spray during the active growing season once there is enough leaf cover to absorb herbicide. In dense thickets it may be useful to roll empty 200 litre drums or place corrugated iron sheets on the thicket to gain access for foliar spraying.

In the event of re-establishing a previous eucalyptus crop, focus should be given to kill the regrowth or coppice from stumps. The coppice of some eucalypts, such as *E. dunnii*, *E. macarthurii* and *E. smithii*, are difficult to kill.

The choice of the appropriate herbicide is therefore crucial. Ensure that the herbicide is registered for use on the specific species. To obtain good results when spraying coppice, it is essential to ensure that all the leaves are sprayed.

3.1 Application

- Unless stated otherwise on the chemical label, chemicals should not be applied in windy conditions, in rain or when heavy rain is expected in an area, nor in extreme dry weather, frosted or snow conditions.

sappi

- Chemicals should not be applied in proximity of water courses, lakes, reservoirs, and open dams, unless specifically formulated for use by the manufacturer.
- No use of chemicals in any other mixture other than prescribed by the manufacturer.
- Application should be done strictly according to the directions on the label.

3.2 Health and safety

All employees mixing and/or applying chemicals should be trained in safe working procedures and should wear the prescribed protective clothing.

3.3 Aerial chemical spray

Although aerial spraying could be a very cost-effective method for clearing land for establishment and re-establishment, the hazardous nature of the operation and possible negative impacts underline the need for stringent guidelines and control. Although this is probably the best method to use when pressed for time, it is very reliant on weather conditions.

Ensure that the site is visited with the pilot to evaluate the scope of the weed problem, to note terrain features, and to identify potential impacts on neighbouring crops, other areas, and homesteads. Mark the area to be sprayed with corner flags.

Weather conditions are critical for any type of aerial spraying. There should be no wind at all when spraying, the temperature should be below 20°C and the humidity should be higher than 40%.

Problems associated with aerial spraying include contamination of soil and water, contravention of legal requirements, risk to peoples' health, indiscriminate loss of unplatable habitats within or near the plantable area, and possible spray drift on neighbouring crops. The hazardous nature of the operation and possible negative impacts underline the need for stringent guidelines.

3.4 Treating stumps by frilling and applying herbicide

Chop right around the stump (no gaps in the frill) at an angle of 45° into the cambium. In the case of multiple stumps all the stems should be frilled as low as possible. Use a narrow-angle solid cone for spraying. Spray until well wet but avoid drip off or spill.

3.5 Killing stumps immediately after felling

This method of stump treatment will only be successful if the stumps are treated as soon as possible after felling, preferably directly after felling. The Institute for Commercial Forestry Research (ICFR) trials have shown that if stumps are treated within 15 minutes after felling, a kill of 80% can be expected. When the stumps are treated 30 minutes after felling, the success rate drops to 40%.

Add dye to chemicals that don't have a colouring agent to ensure that all stumps are treated (Photo 1). Use hand sprayers, paint brushes or low-pressure knapsack sprayers with narrow-angle solid cone nozzles for spraying. Spray till wet, but do not let the chemicals run off.



Photo 1: Dye added to chemical. ³

Do not burn slash within at least three months after treatment, as the stumps will coppice again. A waiting period of six months is recommended.

4. Clearing land mechanically (refer to Chapter 8 Maintenance)

These control methods range from ring-barking trees, felling, de-barking the stumps, mulching (refer photos 2 & 3), disking or grading, and even to the use of bulldozers. A great advantage of this method is the high degree of selectivity. The main disadvantage is that it is costly in terms of time and manpower.

When clearing land mechanically using heavy equipment such as mulchers, terrain will determine the effectiveness of the operation. Mechanical clearing is not recommended when the slope exceeds 18%. Rocks and boulders will also cause problems when using mechanical methods.



Photo 2: Effect of mulching ¹



Photo 3: Lightweight mulcher ideal for the small-scale timber farmer. It needs a 100 Kw tractor. ²



Photo 4: This de-stumper extracts stumps up to 600mm diameter by cutting them off 80mm below ground level. ²

5. Use of fire

While fire can be used as a means of removing dense infestations, it can create ideal conditions for the regeneration of the species from the seedbanks in the soil. Fire is useful when applied to control the re-growth of weeds as it means that the quantity of seeds produced is reduced. Uncontrolled application of fire will only increase the existing problem.

If used judiciously, fire can be an important and cost-effective tool if used with other methods of control, however if used irresponsibly it can lead to degradation of the soil. It is especially important for maintaining some natural habitats, such as grasslands and open savanna in a healthy condition, which in turn reduces the potential invasion of alien plants.

Burning should normally be done during the wet season, after about 20mm of rain. Small saplings, seedlings and bramble infestations in grasslands can be burnt standing. Larger bushes and trees shall be felled and de-branched, preferably two months before the anticipated burning.

Smaller shrubs, creepers and bushes should be slashed as low as possible, preferably below 15cm. Where there are only small amounts of slash stack the brush and burn. Large amounts of slash should be spread over a wide area, thereby avoiding large stacks.

References

¹ Photo by J Jansen.

² <https://saforestryonline.co.za/>

³ Photo by M Louw.

CHAPTER 5 - SITE PREPARATION	Page
1. Establishment	56
2. Re-establishment	60
3. Spacing	60
4. Pitting	61
5. Planting restrictions	64
6. References	66

The establishment or re-establishment of plantations is usually preceded by some form of site preparation. This is to achieve optimum tree growth through the improvement of soil as a medium for root growth and the removal of competing vegetation near the tree¹. The type and method of site preparation may determine:

- seedling survival.
- initial tree growth rates.
- final yield of timber.

Site preparation operations must be related to prevailing site conditions and must be cost-effective since these initial costs are compounded over an extended period. Preparation techniques that minimize impacts on soil loss, damage to the soil structure and carbon loss through oxidation should be practiced¹. Incorrectly applied or careless operations particularly on sensitive soils may result in long-term damage to the site.

Soil is a living, dynamic resource that supports plant life, and on which agricultural and timber crops depend for their growth. Each soil type has its own characteristic chemical, physical and morphological properties. To make sound management decisions, managers should have a working knowledge of the soils on the property¹.

Soil health¹ is a concept that embraces the chemical, physical and biological functioning of soils. Soil carbon (soil organic matter content) is one of the most important factors in the biological functioning of soils and measuring total soil carbon is a good measure of soil health. Soil carbon:

- stores over 90% of the nitrogen of the soil.
- has many sites that hold minerals and thus increase the soil's available nutrients.
- prevents nutrient leaching by holding them.
- promotes good soil structure.
- encourages macro-organisms (e.g., earthworms) that form pores in the soil and thus assist plant growth by allowing micro-organisms to turn the nitrogen in the air into nitrate and ammonia.
- improves soil water relationships by increasing rain absorption and decreasing water loss from run-off.

The selection of a particular preparation method is largely determined by the status of the site (virgin site, ex-agricultural site, or ex-forestry site).

1. Establishment

Do as little as possible to achieve the desired effect; minimal tillage and disturbance of the soil should be standard practice. The method of land preparation used should be determined by the site factors (Table 1), the norms for site preparation in the forest industry (Table 2) and the restrictions listed in the Conservation of Agricultural Resources Act (CARA).

Site condition	Guidelines
<p>Sites with deep apedal soils or sites that do not have a specific physical problem (e.g., root impeding layers).</p>	<p>a) Minimum tillage should be practised. This includes a shallow (not more than 500 mm) ripping or ploughing operation.</p> <p>b) Light tillage (single-pass operation using light equipment could be utilised to:</p> <ul style="list-style-type: none"> • prepare planting positions. • to assist in weed competition control.
<p>Non-cohesive soils (Fernwood soils and soils with clay contents of less than 15%).</p>	<p>These sites will not benefit from tillage and this option should be excluded. Pitting recommended.</p>
<p>Sensitive unstable soils (i.e., soils that set hard and tend to erode).</p>	<p>a) Should receive no or very little tillage as disturbance could lead to physical problems.</p> <p>b) If tillage is deemed necessary then it should be conducted strictly along the contour with slash left on site.</p> <p>c) Slash should not be burned on these soils.</p>
<p>Water repellent soils resist wetting because of the formation of a coating of hydrophobic substances of organic origin on soil particles. The effect can result in reduced infiltration into soil and therefore increased overland flow.</p> <p>The topsoil of water repellent soils may remain dry even after a rainstorm and this leads to high mortalities of young seedlings and reduced productivity of successive rotations as repellence increases.</p>	<p>a) The most effective way to improve infiltration, but keep disturbance to a minimum, would be the use of ripping or subsoiling tines.</p> <p>b) Such ripping must be along the contour using the correctly designed winged tines, thus resulting in furrows into which seedlings are planted.</p>
<p>Compacted soils, caused mostly by plantation operations, but also by the weight and movement of the tree crop will impede root development if bulk densities exceed the following:</p> <ul style="list-style-type: none"> i) 1.55 g/cm² on clay-loams ii) 1.65 g/cm² on silt loams iii) 1.80 g/cm² on fine sandy loams iv) 1.85 g/cm² on loamy fine sands <p>Severely compacted soils show increases in bulk densities down to depths of over 1 metre.</p>	<p>a) On most sites suffering from compaction, tillage should be restricted to extraction rows.</p> <p>b) Disc-ploughs or chisel-ploughs can be used to loosen surface compaction, provided slash layers are light.</p> <p>c) Large winged sub-soiler tines can fracture soils to depths of over 1 metre if soil moisture levels are not too high and the tines have been designed to heave soil. Such tining must create crescent failure and not lateral failure, the latter resulting in smearing of the profile and very little loosening occurring.</p>

<p>Soils containing root impeding layers (e.g., oukclip).</p> <p>These sites would include soils containing stone lines, waterlogged sub-soils, sub-soils with well weathered saprolite, a firm layer overlying a more friable horizon, or vice versa and possibly structured sub-soils.</p>	<p>Cultivation where root development is restricted by some impeding zone should result in increased tree growth.</p>
---	---

Table 1: Recommended land preparation methods for various site conditions.¹

Slope % (slope angle°)	Soil erodibility	Type of cultivation	Tillage direction	Remarks
0-8% (4.6°)	0-12% (7°)	Full conventional.	Across slope.	Leave surface as rough as possible.
9-12% (8.5°)		1. Full primary cultivation with tined implement only. 2. Strip cultivation with any implement leavening minimum 1m between strips which may be ripped or sprayed.	Across slope. Across slope.	
	13-20% (11°)	Full unrestricted primary cultivation followed by secondary cultivation along the plant line only.	Across slope.	
16-25% (14°) *	21-30% (17°)	Full primary cultivation with tined implement only.	Across slope.	Plant within 1 month. Weed control via herbicide strip (1.5m wide or more) or hand hoe around the tree, no mechanical control.
21-30% (17°) *	31-40% (22°)	Single rip/sub-soiler tiner along tree line.	Across slope.	Crawler tractor recommended. Weed control as above, spray prior to planting.

* Requires permission from the executive officer (Department of Agriculture, Forestry and Fisheries (DAFF)).

Table 2: Norms for site preparation.

The Conservation of Agricultural Resources Act 43 of 1983 defines cultivation, in relation to land, any act by means of which the topsoil is disturbed mechanically. The following regulations specifically address soil erosion and are applicable to forestry operations:

- except with written authority, no virgin land shall be cultivated (land which in the opinion of the executive officer has at no time during the preceding ten years been cultivated). Note that this restriction is carried through to the National Environmental Management Act (NEMA): Environmental Impact Assessment Regulations.
- except with written authority, no land shall be cultivated if it:
 - has a slope of more than 20% (Figure 1).
 - has a slope of more than 12% and is situated in certain magisterial areas such as Eshowe with specified erodible soils and physical properties. This prohibition does not apply to land which was under cultivation on the date of the commencement of the regulations (i.e., 1 June 1984), provided such land is protected against excessive soil loss due to erosion through the action of water.
- cultivated land shall be protected against excessive soil loss as a result of erosion through the action of water or wind.

To calculate the slope percentage:

Slope (%) = $V/D \times 100$ where V is vertical distance and D is horizontal distance

To calculate the slope angle, use the equation:

θ (degrees) = $\tan^{-1}(V/D)$ where θ is the slope angle in degrees

To convert slope percentage to degrees:

θ (degrees) = $\tan^{-1}(\text{Slope \%}/100)$

To convert slope degrees to percentage:

Slope % = $\tan(\theta) \times 100$

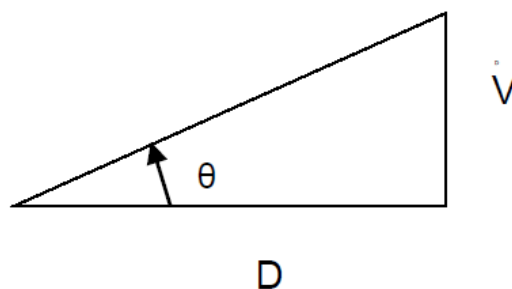

Figure 1: Calculating slope percentage.

On ex-agricultural sites very firm “plough pans” commonly develop as a result of continuous historical tillage operations. This results in an abrupt change in soil strength from the loosened topsoil to a compacted underlying layer. Roots do not penetrate easily across such abrupt changes in soil strength resulting in poor tree growth or tree growth that does not match the potential of the site.

This “plough pan” layer can be loosened effectively by a ripping operation, implemented when soil moisture levels are low. The ripping operation can be followed by further cultivation to break up large clods and help control weeds. Ripping operations should be implemented across the slope to minimise accelerated soil erosion of the rip line¹.

2. Re-establishment (refer to Chapter 4 Land Clearing)

Tree growth responses to site preparation on timber regeneration sites are not as clearly defined as on newly established sites. Improved growth response to intensive site preparation on regeneration sites is often not achieved and any initial responses do not generally persist. This is largely because the competing virgin grassland has already been removed.

In addition, the previous tree crop has altered site conditions through root activity, litter build up and changes in biological soil activity. It is therefore recommended that minimal tillage be implemented, usually in the form of a pitting operation (hand pick, trowel, or mechanical auger)¹. Shallow ripping is a viable and cost-effective alternative to pitting, although it is unlikely to provide better long-term growth benefits than pitting only².

De-stumping is sometimes implemented on sites with large multiple coppiced stumps to facilitate access for replanting and future harvesting/extraction operations. De-stumping methods that minimise soil disturbance should be selected (grinding or chipping rather than stump extraction). It is an expensive operation and highly unlikely to improve growth in subsequent rotations¹.

3. Spacing

Spacing or stocking density is dependent on the growth potential of the site, the genus or species, and the planned product (e.g., sawlogs or pulpwood). A rectangular espacement has become more popular with seedlings planted in rows with a fixed spacing between the rows.

A wider spacing between rows favours mechanisation of silviculture and mechanical harvesting operations. The higher density of *P. patula* is to compensate for potential pitch canker fungus (*Fusarium circinatum*) related mortality.

Genus and species	Spacing	Stems/ha
1. Pines		
1.1. <i>Pinus patula</i>	3.0m x 2.0m	1,667
	3.5m x 1.7m	1,680
1.2. All other pines and pine hybrids	3.0m x 2.5m	1,333
	3.5m x 2.1m	1,360
2. Eucalypts		
2.1 KwaZulu-Natal and Mpumalanga, excluding Zululand coast	3.0m x 2.0m	1,667
	3.5m x 1.7m	1,680
2.2 Zululand coast	3.0m x 2.2m	1,515
	3.4m x 1.9m	1,548
3. Wattle	3.0m x 1.5m	2,222

Table 3: Spacing ⁵

4. Pitting

Pitting (by hand pick, trowel, or mechanical pitter) can be used to prepare the site for planting. Some tree farmers don't employ pitting at all, but merely open a small hole when planting. Competing vegetation along the tree line can be controlled using herbicides¹. Pitting is done to improve the physical environment into which a young tree is planted².

Benefits generally associated with this practice are:

- decrease in the soil bulk density and physical strength.
- improved water infiltration rates.
- promotion of higher oxygen diffusion rates.
- increased rates of organic matter decomposition in the topsoil.
- removal of weed competition around the seedling.

Pitting is an expensive operation, and cost savings can substantially reduce establishment costs.

Suggested pit size standards are 25 cm deep and 35 cm wide for **re-establishment** purposes, and 25 cm deep and 50 cm wide for **establishment** (Figure 2). Weed control should be practiced in the area around the pit and not just in the pit.

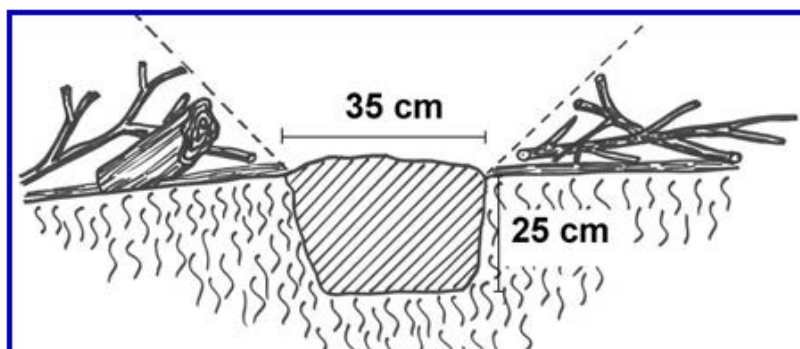

Figure 2: Pit size for re-establishment.



Photo 1: This innovative device is designed to take the weight of a mechanical pitter off the shoulders of the operator.⁶

Timber growers are often innovative. As the saying goes “*n boer maak 'n plan*”, refer to Photos 2 and 3 for examples of loggers adapted as mechanical pitters. High costs and smearing of pits in clay soils could be disadvantageous in these cases.



Photo 2: Logger converted as a pitter by Holley Brothers, Wartburg.⁴



Photo 3: Logger conversion by Ralph Voigts, Hilton.⁴

The compact excavator with a planting attachment displayed in Photo 4 can undertake four pits from any stationary position.⁶



Photo 4: A compact excavator with a head attachment.⁶

5. Planting restrictions

The key legal requirement for the establishment of plantations is compliance with the National Water Act (Act No. 36 of 1998). A plantation must have evidence that it has committed to the Department of Water and Sanitation (DWS) licencing and verification process for stream flow reduction. If not, the following applies:

1. The plantation is registered for water use, and
2. There is a water use license, or
3. There is a planting permit, or
4. The plantation was established prior to 1998 in Traditional Authority areas, or
5. The plantation was established prior to 1972 in all non-Traditional Authority areas.
6. Plantations established after 1998 have an Environmental Impact Assessment under the National Environmental Management Act, 1998 (Act No. 107 of 1998).

Wetlands and riparian areas (areas associated with a water course) must be delineated (indicating the exact position of a boundary), prioritised and protected from forestry impacts by adequate buffers of appropriate vegetation. The DWS guidelines state that for forestry the minimum buffer between the outer edge of the temporary zone of a wetland, or the outer boundary of a riparian zone and the plantings would normally be 20 meters, unless specified to the contrary in a permit or water use license. Where the buffer zone is less there must be clear justification. Refer to Figures 3 and 4.

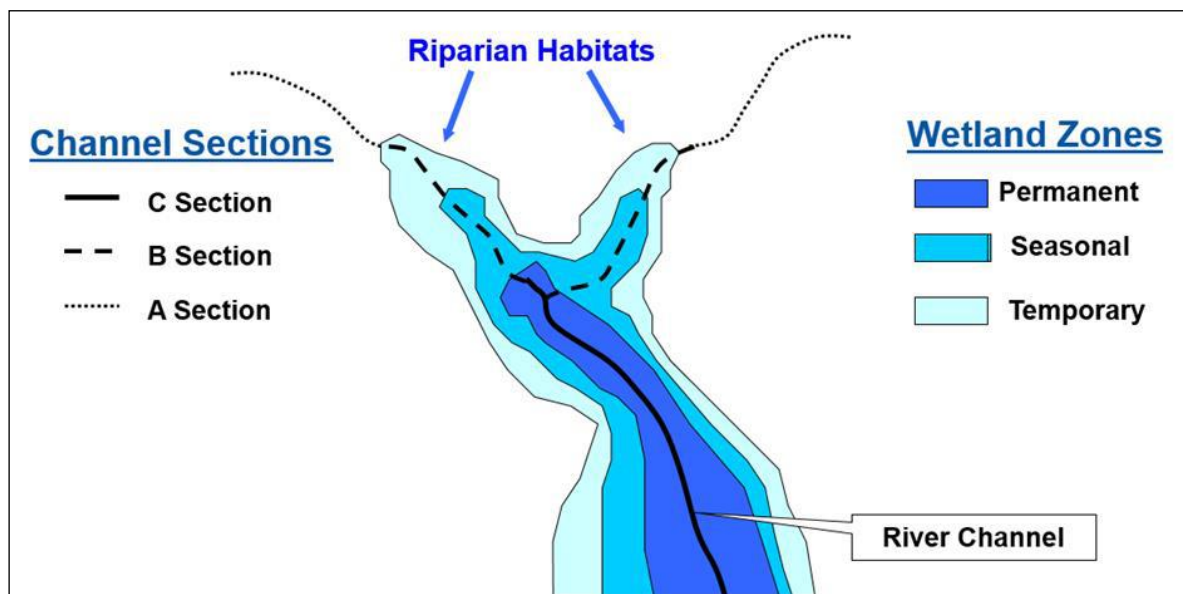

Figure 3: Riparian habitats & wetland zones.³

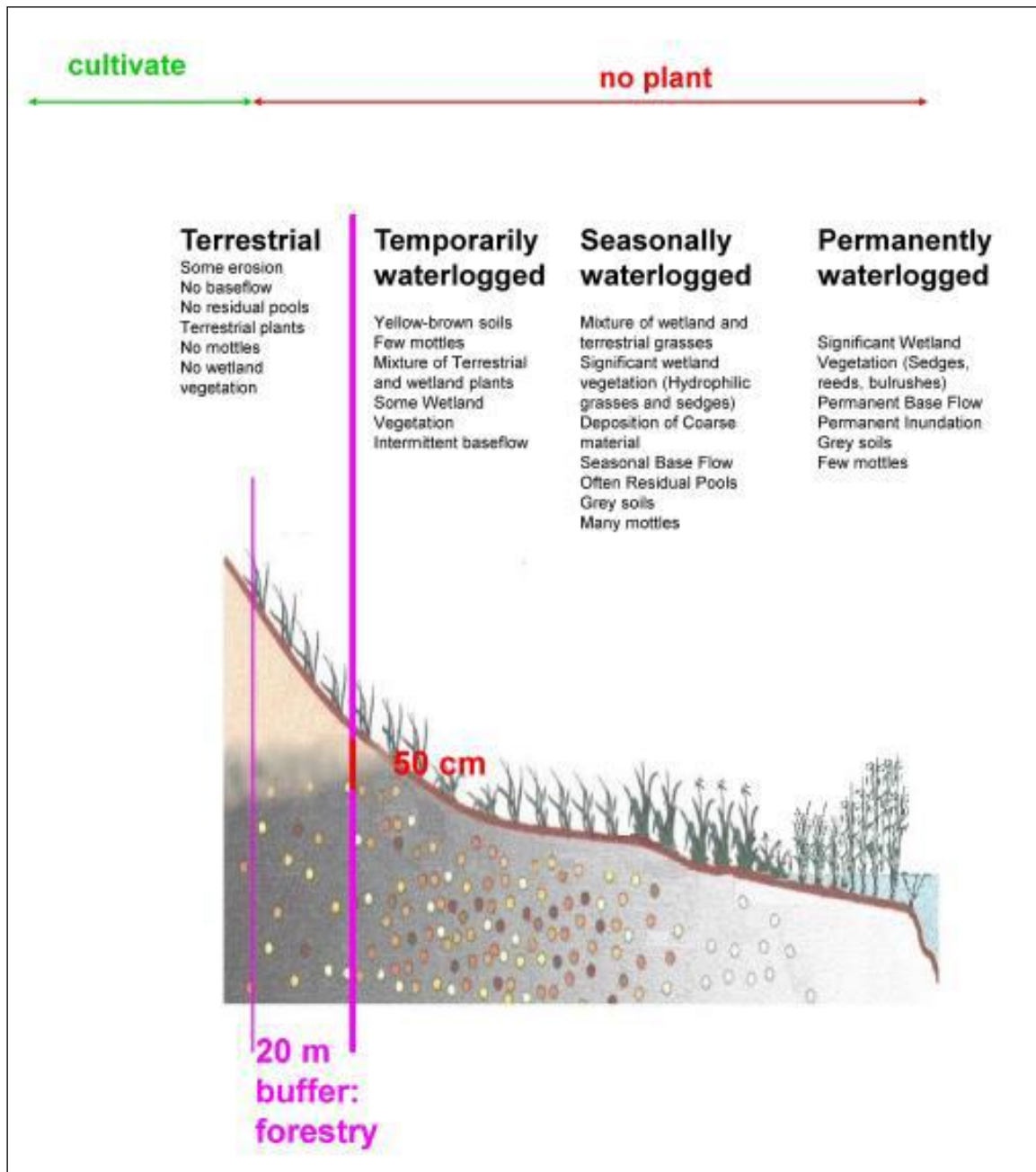

Figure 4: 20m buffer.³



Photo 5: Good delineation practice.³

6. References

- ¹ Environmental Guidelines for Commercial Forestry Plantations in South Africa (2021) 4th edition. Forestry South Africa. <https://www.forestrysouthafrica.co.za/2021-environmental-guidelines/>
- ² Institute for Commercial Forestry Research (2000) Innovations. Pietermaritzburg, South Africa.
- ³ Snyman, K (2009) Wetland and riparian habitats. Presented to Sappi FSC® Group Scheme AGM.
- ⁴ Photos by A Jooste.
- ⁵ Sappi Forests Risk Management System (Crous, J (2020) ES1doc006, v2.2).
- ⁶ <https://saforestryonline.co.za/>

CHAPTER 6 – PLANTING	Page
1. Planting window	67
2. Planting	67
2.1 Planting conditions	67
2.2 Planting technique	68
3. Blanking	72
4. Planting productivity	72
5. References	78

The beginning of the growth cycle for any plantation starts with the planting of the seedlings. It's the most important day in the life of a tree! The objective of planting is to obtain a fully stocked stand of healthy trees. Poor planting survival is usually attributed to planting-stock quality or drought; however, many failures are caused by improper handling or planting technique. Planting stock is very sensitive to damage and stress. Stress can result from physical damage (shaking, ripping, squeezing, and dropping) or environmental effects (overheating or moisture fluctuations). Stressed plants must divert resources into repairing cellular damage, rather than putting energy into establishment and growth.

Successful establishment, therefore, depends on providing meticulous care throughout the transport and planting process to minimise *transplant shock*. The investment in tree breeding and nursery cultural practice can be lost if planting and handling practices are not correctly implemented. Furthermore, the financial loss of failed establishment includes the planting fee plus the cost of the planting stock and that of repeated site preparation.

1. Planting window

Region	From	To	Remarks
Mpumalanga Lowveld	October	March	Avoid hot Dec - Jan
Mpumalanga Highveld	September	February	Frost
Natal Midlands	October	April	
Natal South coast	September	April	
Natal North coast (Zululand)	March	August	Avoid Jan – Feb

Table 1: Suggested planting window.

2. Planting

2.1 Planting conditions

- The key to good survival lies in the ability of the root system to absorb water and nutrients soon after planting.
- Delay planting if the soil is dry – it should be wet to a depth of 25 to 30 cm. Dry soil is difficult to pack around the roots and cannot supply moisture when the plants need it most. Wait for sufficient rainfall to recharge the soil moisture.
- Postpone planting when planting conditions deteriorate (increase in air and soil temperature and windspeed, or a drastic decrease in relative humidity).
- Water the seedlings and cuttings thoroughly before planting – this will assist with extraction from the trays (refer Chapter 3 Seedlings and cuttings).

sappi

2.2 Planting technique - preventing moisture stress and damage to plants

- Carry the plants to the planting area in the original container (Figure 2.5b). Prevent staff carrying plants by hand (out of the container) as the root plug will rapidly dry out.
- Open the planting pit or make a hole with a planting tool to a depth 3-5 cm deeper than the plug height (Figure 1.1).
- Pour water into the hole, especially in conditions of poor soil moisture. Not more than 2 litres – it will be wasted as the soil cannot store more water in the area surrounding the root plug. Refer Photos 1 & 2. Consider using hydrogel as an alternative – refer Photos 6 - 8.



Photos 1 & 2: Opening a hole & watering.³

- Carefully extract a healthy plant from the container:
 - Sappi 49 tray – push the bottom of the plug while gently pulling on the stem (Figure 1.2).
 - Unigro tray – tap on insert with the planting tool to loosen plug (Figure 1.3). Avoid squeezing the insert.
 - Clonal cuttings especially require care when planting as their roots are delicate, and their root structure differs to that of seedlings. Stability is often a problem, i.e., they can topple over more easily.

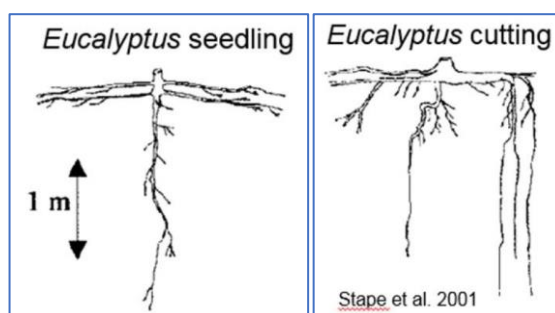

- Ellepot tray – these plants come in paper sleeves, which are planted directly into the soil, where the paper gradually biodegrades. There is no need to remove the paper before planting. The sleeve reduces the risk of root damage during transport, handling, and planting.

sappi

- Handle plants by the shoot; avoid any handling of the roots (Figure 2.5c). Prevent damaging the root plugs or stems at any stage.
- Holding on to the stem, allow the root plug to hang naturally in the pit (Figure 1.4). Refer Photos 3 - 5. Position the top of the plug 3-5 cm below the soil surface to ensure correct planting depth. Shallow planting results in early plant mortality, particularly during droughts. Planting that is too deep can also result in plant death.



Photos 3, 4 & 5: Positioning the root plug.³

sappi

- Using hydrogel: mix 3 to 6 g hydrated in 1 litre of water. Cover root plug with soil, add hydrogel and lightly cover hydrogel with soil. There is an exponential relationship between increased hydrogel and soil water-holding capacity². Refer Photos 6 - 8.



Photos 6, 7 & 8: Use of hydrogel.²

- Ensure good root to soil contact by breaking up clods within the planting pit as far as is practical.
- Pack moist soil firmly around the roots to anchor the plant and to eliminate air pockets, which would allow the roots to dry out (Figures 1.5 and 1.6). Avoid mixing the soil with sticks, grass, clods, or rocks.
- Avoid the use excessive force to compact the soil around the stem (Figure 2.6).
- Re-watering is crucial in drought conditions. The frequency will depend on environmental conditions. The water applied at planting should last 7-14 days. Re-water with 1-2 litres (no hydrogel) at least every 14 days after planting until there is rain. Check soil moisture within the planting pit at root plug depth to determine if re-watering is required.

Refer to Figure 1 for the correct planting technique, and to Figure 2 for common mistakes during planting.

sappi

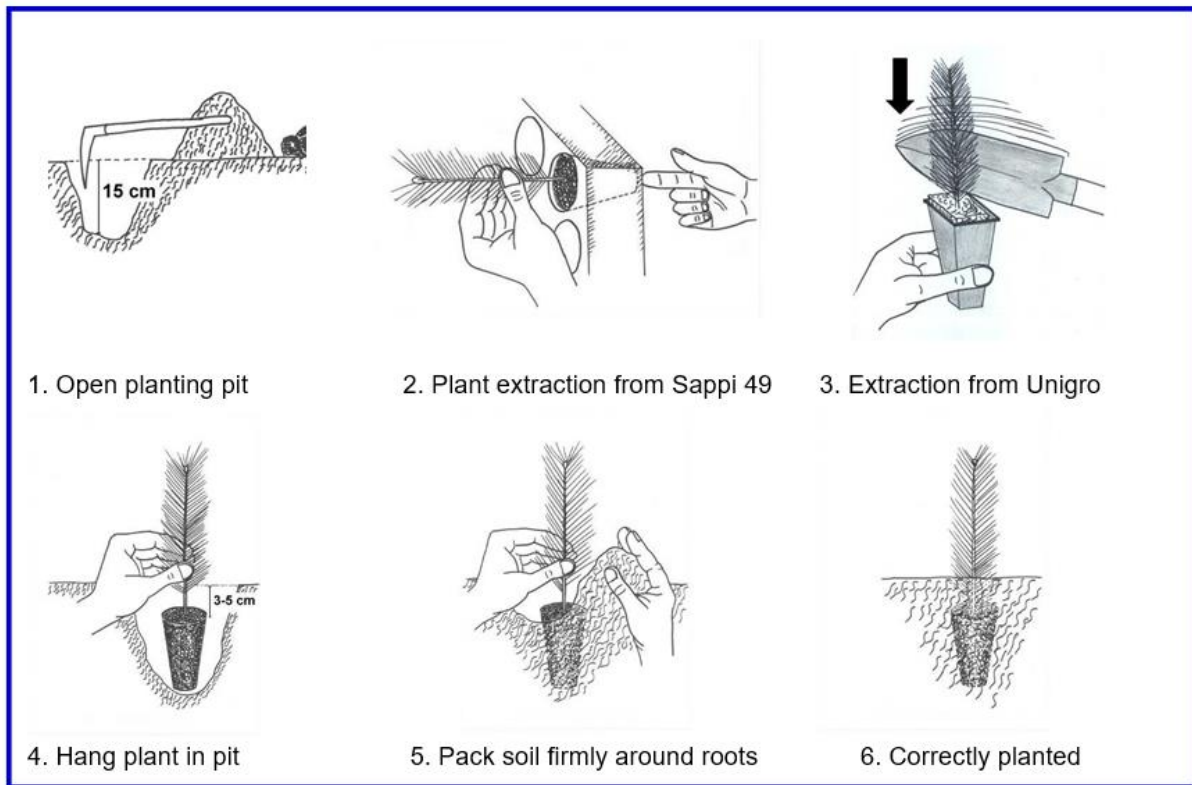

Figure 1: Correct planting technique.

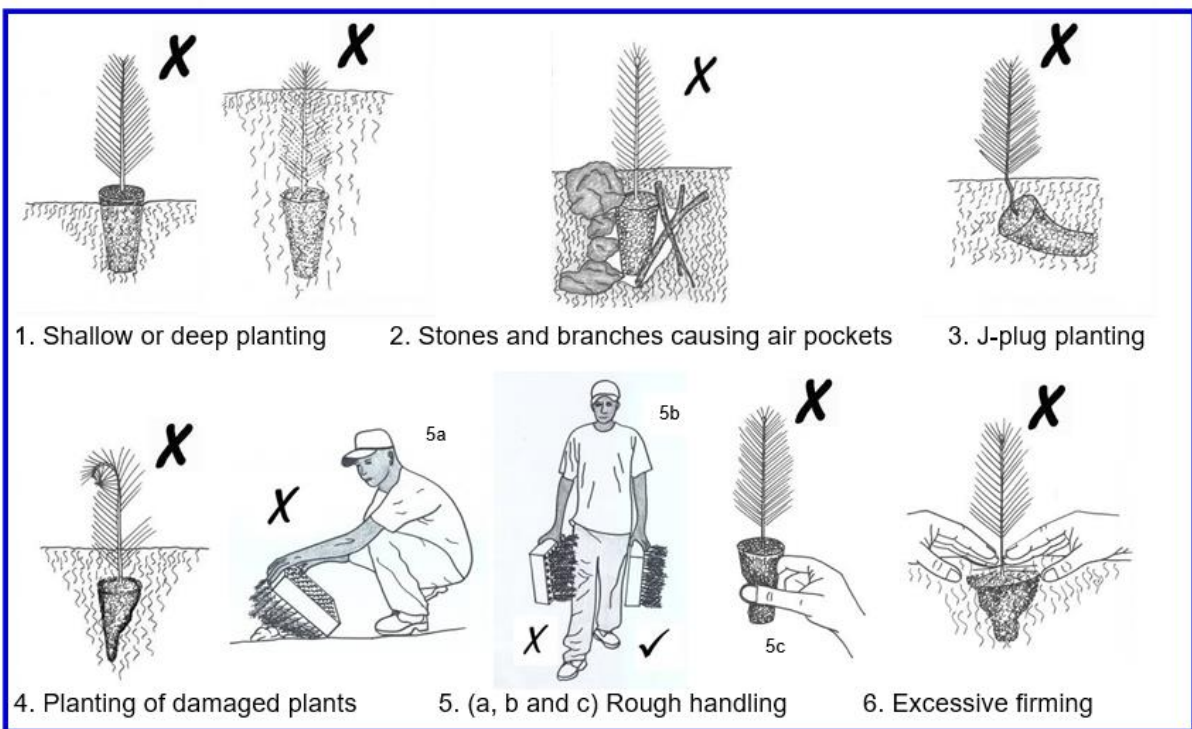

Figure 2: Common mistakes during planting.

sappi

Although most planting is done manually, mechanised planting machines have been developed for use by large forestry companies. The machine displayed in Photo 9 allows six planters to apply gel and plant simultaneously. The seedlings are carried in buckets by the planter, who drops them into a tube for planting and then tramps down the soil around the seedling with the feet. It is powered by a self-drive machine and features hydraulic folding booms. It plants up an average of 7 ha per day at a rate of 40-50 plants per minute with six planters.⁴



Photo 9: Planting machine.⁴

3. Blanking ¹

To ensure good stocking, a survey of the planted areas should be done about four weeks after planting eucalypts or three months after planting pines. If the survival is less than 92%, blanking should be done within six weeks after planting in the case of eucalypts or 16 weeks in the case of pines.

All seedling trays are to be returned to the suppliers.

4. Planting productivity <https://www.forestrysolutions.net>

The tables below detail the production targets for planting. The standards are based on a 9 hour (540min) work shift with 8 hours (480min) being allowed for productive work in field. These include fatigue and operational allowances associated with the activity.

Targets will vary according to the prevailing working conditions, for which points are allocated on the respective variable conditions' tables. Prior to determining a task, the points are calculated and taken into consideration.

4.1 Eucalypts

- 4.1.1 Planting tool
- 4.1.2 Trowel

Page
73
74

sappi

4.1.3 Planting in coastal sands	75
4.2 Pine	
4.2.1 Planting tool	76
4.2.2 Trowel	76
4.3 Wattle	
4.3.1 Planting tool	77
4.3.2 Trowel	77

4.1 Eucalypts

Condition	Variable	Points
Average lead distance (refill to work area)	0 – 300m	0
	300 – 400m	1
	400 – 500m	2
Slope conditions (%)	0 – 20%	0
	21 – 30 %	1
	30 %>	2
Infield surface condition	Moderate - clean	0
	Medium regrowth/obstacles	1
	Dense regrowth/obstacles	2
Ground roughness	Smooth	0
	Rough	1
	Very rough	2
Planting with water	Water supplied	2
	Water collected	4
Total		

4.1.1 Planting tool

1333 spha

Points	0	1	2	3	4	5	6	7	8
Trees/shift	650	600	550	500	450	400	350	300	250
Ha/shift	0.49	0.45	0.41	0.38	0.34	0.30	0.26	0.23	0.19
Manday/ha	2.05	2.22	2.42	2.67	2.96	3.33	3.81	4.44	5.33

1372 spha

Points	0	1	2	3	4	5	6	7	8
Trees/shift	650	600	550	500	450	400	350	300	250
Ha/manday	0.49	0.45	0.41	0.38	0.34	0.30	0.26	0.23	0.19
Manday/ha	2.11	2.29	2.50	2.74	3.05	3.43	3.92	4.57	5.49

1666 spha

Points	0	1	2	3	4	5	6	7	8
Trees/shift	650	600	550	500	450	400	350	300	250
Ha/manday	0.39	0.36	0.33	0.30	0.27	0.24	0.21	0.18	0.15
Manday/ha	2.56	2.78	3.03	3.33	3.70	4.17	4.76	5.55	6.66

sappi

1736 spha

Points	0	1	2	3	4	5	6	7	8
Trees/shift	650	600	550	500	450	400	350	300	250
Ha/manday	0.37	0.35	0.32	0.29	0.26	0.23	0.20	0.17	0.14
Manday/ha	2.67	2.89	3.16	3.47	3.56	4.34	4.96	5.79	6.94

4.1.2 Trowel

1333 spha

Points	0	1	2	3	4	5	6	7	8
Trees/shift	600	550	500	450	400	350	300	250	225
Ha/manday	0.45	0.41	0.38	0.34	0.30	0.26	0.23	0.19	0.17
Manday/ha	2.22	2.42	2.67	2.96	3.33	3.81	4.44	5.33	5.92

1372 spha

Points	0	1	2	3	4	5	6	7	8
Trees/shift	600	550	500	450	400	350	300	250	225
Ha/manday	0.45	0.41	0.38	0.34	0.30	0.26	0.23	0.19	0.27
Manday/ha	2.29	2.44	2.74	3.04	3.43	3.92	4.57	5.26	6.10

1666 spha

Points	0	1	2	3	4	5	6	7	8
Trees/shift	600	550	500	450	400	350	300	250	225
Ha/manday	0.36	0.33	0.30	0.27	0.24	0.21	0.18	0.15	0.14
Manday/ha	2.78	3.03	3.33	3.70	4.17	4.76	5.55	6.66	7.40

1736 spha

Points	0	1	2	3	4	5	6	7	8
Trees/shift	600	550	500	450	400	350	300	250	225
Ha/manday	0.35	0.32	0.29	0.26	0.23	0.20	0.17	0.14	0.13
Manday/ha	2.89	3.16	3.47	3.56	4.34	4.96	5.79	6.94	7.72

4.1.3 Planting in coastal sands (fast planting)

Condition	Variable	Points
Average lead distance (refill to work area)	0 – 300m	0
	300 – 400m	1
	400 – 500m	2
Slope conditions (%)	0 – 20%	0
	20 %>	2
Infield surface condition	Moderate - clean	0
	Medium regrowth/obstacles	1
	Dense regrowth/obstacles	2
Ground roughness	Smooth	0
	Rough	1
	Very rough	2
Planting with water	Water supplied	2
	Water collected	4
Total		

Points	0	1	2	3	4	5	6	7	8
Trees/shift	1100	1000	900	850	800	750	700	650	600
Manday/ha @ 1333spha	1.22	1.33	1.48	1.57	1.67	1.78	1.90	2.05	2.22
Manday/ha @ 1376spha	1.25	1.38	1.53	1.62	1.72	1.83	1.97	2.12	2.29
Manday/ha @ 1666spha	1.51	1.67	1.85	1.96	2.08	2.22	2.38	2.56	2.78
Manday/ha @ 1736spha	1.58	1.74	1.93	2.04	2.17	2.31	2.48	2.67	2.89

4.2 Pine

Condition	Variable	Points
Average lead distance (refill to work area)	0 – 300m	0
	300 – 400m	1
	400 – 500m	2
Slope conditions (%)	0 – 20%	0
	21 – 30 %	1
	30 %>	2
Infield surface condition	Moderate - clean	0
	Medium regrowth/obstacles	1
	Dense regrowth/obstacles	2
Ground roughness	Smooth	0
	Rough	1
	Very rough	2
Planting with water	Water supplied	2
	Water collected	4
Total		

4.2.1 Planting tool

816 spha

Points	0	1	2	3	4	5	6	7	8
Trees/shift	650	600	550	500	450	400	350	300	250
Ha/shift	0.79	0.73	0.67	0.61	0.55	0.49	0.43	0.37	0.31
Manday/ha	1.26	1.37	1.49	1.64	1.82	2.05	2.34	2.73	3.28

1111 spha

Points	0	1	2	3	4	5	6	7	8
Trees/shift	650	600	550	500	450	400	350	300	250
Ha/manday	0.59	0.54	0.50	0.45	0.41	0.36	0.32	0.27	0.23
Manday/ha	1.71	1.85	2.02	2.22	2.47	2.78	3.17	3.70	4.44

1372 spha

Points	0	1	2	3	4	5	6	7	8
Trees/shift	650	600	550	500	450	400	350	300	250
Ha/manday	0.49	0.45	0.41	0.38	0.34	0.30	0.26	0.23	0.19
Manday/ha	2.11	2.29	2.50	2.74	3.05	3.43	3.92	4.57	5.49

4.2.2 Trowel

816 spha

Points	0	1	2	3	4	5	6	7	8
Trees/shift	600	550	500	450	400	350	300	250	225
Ha/manday	0.73	0.67	0.61	0.55	0.49	0.43	0.37	0.31	0.27
Manday/ha	1.37	1.49	1.64	1.82	2.05	2.34	2.73	3.28	3.64

1111 spha

Points	0	1	2	3	4	5	6	7	8
Trees/shift	600	550	500	450	400	350	300	250	225
Ha/manday	0.54	0.50	0.45	0.41	0.36	0.32	0.27	0.23	0.27
Manday/ha	1.85	2.02	2.22	2.47	2.78	3.17	3.70	4.44	4.93

1372 spha

Points	0	1	2	3	4	5	6	7	8
Trees/shift	600	550	500	450	400	350	300	250	225
Ha/manday	0.45	0.41	0.38	0.34	0.30	0.26	0.23	0.19	0.27
Manday/ha	2.29	2.44	2.74	3.04	3.43	3.92	4.57	5.26	6.10

4.3 Wattle

Condition	Variable	Points
Average lead distance (refill to work area)	0 – 300m	0
	300 – 400m	1
	400 – 500m	2
Slope conditions (%)	0 – 20%	0
	21 – 30 %	1
	30 %>	2
Infield surface condition	Moderate - clean	0
	Medium regrowth/obstacles	1
	Dense regrowth/obstacles	2
Ground roughness	Smooth	0
	Rough	1
	Very rough	2
Planting with water	Water supplied	2
	Water collected	4
Total		

4.3.1 Planting tool

1852 spha

Points	0	1	2	3	4	5	6	7	8
Trees/shift	650	600	550	500	450	400	350	300	250
Ha/shift	0.35	0.32	0.30	0.27	0.24	0.22	0.19	0.16	0.13
Manday/ha	2.85	3.09	3.37	3.70	4.12	4.63	5.29	6.17	7.41

2222 spha

Points	0	1	2	3	4	5	6	7	8
Trees/shift	650	600	550	500	450	400	350	300	250
Ha/manday	0.29	0.27	0.25	0.23	0.20	0.18	0.16	0.14	0.11
Manday/ha	3.42	3.70	4.04	4.44	4.94	5.56	6.35	7.41	8.89

2777 spha

Points	0	1	2	3	4	5	6	7	8
Trees/shift	650	600	550	500	450	400	350	300	250
Ha/manday	0.23	0.22	0.20	0.18	0.16	0.14	0.13	0.11	0.09
Manday/ha	4.27	4.63	5.05	5.55	6.17	6.94	7.93	9.26	11.11

4.3.2 Trowel

1852 spha

Points	0	1	2	3	4	5	6	7	8
Trees/shift	600	550	500	450	400	350	300	250	225
Ha/manday	0.32	0.30	0.27	0.24	0.22	0.19	0.16	0.13	0.12
Manday/ha	3.09	3.37	3.70	4.12	4.63	5.29	6.17	7.41	8.23

2222 spha

Points	0	1	2	3	4	5	6	7	8
Trees/shift	600	550	500	450	400	350	300	250	225
Ha/manday	0.27	0.25	0.23	0.20	0.18	0.16	0.14	0.11	0.10
Manday/ha	3.70	4.04	4.44	4.94	5.56	6.35	7.41	8.89	9.88

2777 spha

Points	0	1	2	3	4	5	6	7	8
Trees/shift	600	550	500	450	400	350	300	250	225
Ha/manday	0.22	0.20	0.18	0.16	0.14	0.13	0.11	0.09	0.08
Manday/ha	4.63	5.05	5.55	6.17	6.94	7.93	9.26	11.11	12.34

5. References

- ¹ South African Forestry Handbook (2002) Vol. 1 and 2. Southern African Institute of Forestry.
- ² Sappi Tech Alert (2016) Planting during drought conditions. Alert 1/16.
- ³ Photos by A Jooste.
- ⁴ <https://saforestryonline.co.za/>



1. Fertilising methods and recommendations	79
2. References	82

Fertiliser use in South African plantation forestry is not current practice and the quantities are very low compared with other agricultural land uses.⁵ It is generally only applied at planting with the aim of stimulating early seedling growth. The small quantities applied do not alter site nutrition but rather provide limited localised nutrition. This assists with rapid establishment of seedlings and early canopy closure, resulting in weed suppression and increased tree growth. The use of fertilisers is controlled in terms of the Fertilisers, Farm Feeds, Agricultural Remedies and Stock Remedies Act (Act No. 36 of 1947).²

Consider the following:

- The use of fertilisers has often found to be not viable economically and should therefore only be used where research has shown a potential benefit in terms of increased growth rates.
- Fertiliser should not be applied unless appropriate weed control has been exercised. Keep the seedlings weed free after fertilising because fertiliser increases weed growth.
- Do not fertilise during dry spells or drought.
- Fertilisers should be purchased from registered suppliers.
- Foresters should only use products registered for a specific use.
- Fertilisers should be stored under cover in designated storage areas.²

1. Fertilising methods and recommendations

- A small quantity of agricultural lime can be used to mark pit positions.
- Fertiliser should not be mixed into the planting pit prior to planting as it will reduce tree growth and lead to increased mortality.
- Apply the fertiliser in two slots, 15 to 20 cm away from the seedling stem on the contour (not above and below the seedling) and cover with soil (Figure 1). In case of ripped compartments place fertiliser in two slots located on the rip line. On sandy soils, where fertiliser with a relatively high N-content is applied (e.g., LAN, 3:2:1, etc.), a placement distance of 20 to 25 cm away from the seedling stem is recommended to reduce the risk of root scorch.¹

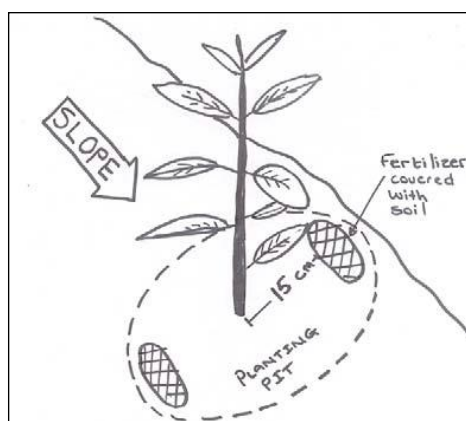

Figure 11: Slots for fertilising.

- The full dosage of fertiliser should be given at planting, but no later than four weeks thereafter (refer Tables 1 and 2).
- When blanking is conducted, care should be taken to not plant seedlings directly on top of applied fertiliser. It is not necessary to re-apply fertiliser after blanking.

Site preparation and/or site characteristics	Recommended quantity of nutrient elements (g/tree)		Recommended fertiliser mixtures and quantities (g/tree)	Macro-nutrient content of recommended mixtures (g/tree)		
	N	P		N	P	K
Re-establishment (ripping or pitting land preparation method)						
> 3% organic C in topsoil	8+	12	60g DAP* + Zn OR 125 g 2:3:1 (22) [†] # + Zn	11	12	0
< 3% organic C in topsoil	14	10	100g 3:2:0 (25) +Zn OR 125g 3:2:1 (25) # +Zn	15	10	0
Old wattle lands	0	15	140g single supers (10.5% P) + Zn OR 75g double supers (20% P) + Zn	0	15	0
Establishment (full cultivation of virgin land)						
> 8% organic C in topsoil	0	15	140g single supers (10.5% P) + Zn OR 75g double supers (20% P) + Zn	0	15	0
3-8 % organic C in topsoil	5+	12	100g ammoniated supers +Zn OR 60g MAP* +Zn	4	12	0
1-3 % organic C in topsoil s	8+	10	100g single supers (10.5%P) + 25g LAN + Zn OR 50g DAP* + Zn	7	11	0

*MAP = mono ammonium phosphate

*DAP = di-ammonium phosphate

*LAN = limestone ammonium nitrate

Preferred mixture for application on soils derived from sandstone and granite as they also contain potassium.

[†] See information box at end of this document to calculate quantities for different fertiliser concentrations.

Table 1: Fertiliser recommendations for *Eucalyptus* in the summer rainfall area (excluding Zululand). Bold typeface indicates the most likely situation. ^{3 4}

Site preparation and/or site characteristics	Recommended quantity of nutrient elements (g/tree)		Recommended fertiliser mixtures and quantities (g/tree)	Macro-nutrient content of recommended mixtures (g/tree)		
	N	P		N	P	K
> 0.7% (High) organic C (OC) in topsoil	-	-	No fertiliser recommended	-	-	-
0.3 – 0.7% (Medium) OC in topsoil	14	10	150g LAN (28% N) +Zn OR 90g Urea +Zn	42	0	0
<0.3% (Low) OC Mostly the crest positions in some landscapes and ex-agricultural lands	14	15	220g 5:2:0 (27) + S, Zn, B, Cu	42	17	0
			OR			
			150 g 4:1:1 (42) + S, Zn, B, Cu	42	10	10
			OR	42	8	16
			350 g Agrofert (Bos #2 mix)			

Table 2: Fertiliser recommendations for *Eucalyptus* in Zululand. Bold typeface indicates the most likely situation. ^{3 4}

Fertiliser codes explained

Example: 3:2:1 (25)

- The 3:2:1 refers to the elemental N:P:K ratio.
- The (25) at the end refers to the concentration of fertiliser within the bag, i.e., a 50 kg bag x 25% = 12.5 kg of N, P and K.
- To calculate individual quantities of N, P and K:
 - N (Nitrogen) = $3 / (3+2+1) \times 12.5 = 3/6 \times 12.5 = 1/2 \times 12.5 = 6.25$ kg
 - P (Phosphorus) = $2/6 \times 12.5 = 1/3 \times 12.5 = 4.17$ kg
 - K (Potassium) = $1/6 \times 12.5 = 2.08$ kg

† **How to adjust the fertiliser quantity if the fertiliser concentration differs from the recommended fertiliser**

Example:

For a specific site the recommendation according to Table 1 is to apply 125 g of 3:2:1 (25) + Zn to each eucalypt seedling, but the supplier only has 3:2:1 (38) + Zn in stock.

Calculation to adjust dosage:

The fertiliser mixture is the same (3:2:1) but the fertiliser in stock is “stronger” as it contains 38% of elemental fertiliser as opposed to 25% as in the recommendation.

Thus, the available fertiliser contains $38/25 = 1.52$ times the quantity of fertiliser in the recommendation and the dosage should be reduced by this ratio.

Quantity per tree = $125 \text{ g} / 1.52 = 82 \text{ g}$.

Thus only 82 g of 3:2:1 (38) fertiliser per tree is required.

Evaluating fertiliser prices

Example:

Supplier 1 has 3:2:1 (25) fertiliser in stock for R4,000 per ton (excluding transport cost) and supplier 2 has 3:2:1 (38) fertiliser in stock for R5,500 per ton.

Calculation:

Because the fertiliser concentrations differ the prices cannot be compared directly. One ton (1,000kg) fertiliser from supplier 1 contains 0.25 t NPK (25%), while a ton from supplier 2 contains 0.38 t NPK (38%). Thus, you will have to buy $38/25 = 1.52$ times the quantity of fertiliser from supplier 1 to get the same nutrients as one ton from supplier 2. Thus $1 \text{ t} \times 1.52 = 1.52 \text{ t}$ of fertiliser from supplier 1 will cost $R4,000 \times 1.52 = R6,080$.

Conclusion:

Buying fertiliser from supplier 2 is the most economic, and thus the best choice, as you will save $(R6,080 - R5,500) = R582$ per ton or $(R580/R5,500) \times 100 = 10.5\%$, although supplier 2's price per ton is more than that of supplier 1. Further savings on transport and application can be added if fertiliser from supplier 2 is purchased as it is more concentrated and less tons must be transported to the plantation.

2. References

- ¹ Crous, J (2013) Fertiliser placement at planting: a review. Sappi Technical Report 33/2013.
- ² Environmental Guidelines for Commercial Forestry Plantations in South Africa (2021) 4th edition. Forestry South Africa. <https://www.forestrysouthafrica.co.za/2021-environmental-guidelines/>
- ³ Institute for Commercial Forestry Research (2000) Fertiliser recommendations for commercial hardwood species in South Africa. ICFR Innovations 2000/02, Pietermaritzburg.

sappi

- ⁴ Viero, P and Upfold, S (2006) Eucalypt toolbox: Fertilising for Eucalypts. ICFR Technical notes and Innovations 04/2006 Institute for Commercial Forestry Research, Pietermaritzburg.
- ⁵ FAO (2006) Fertilizer use by crop. FAO Fertilizer and Plant Nutrition Bulletin 17. Food and Agriculture Organization of the United Nations. Viale delle Terme di Caracalla.



Champions at Satico plantation

CHAPTER 8 – MAINTENANCE	Page
1. Weed control	84
1.1. Critical vegetation management interventions/phases	85
1.1.1. Between harvesting and planting	85
1.1.2. Between planting and canopy closure	85
1.1.3. Between canopy closure and harvesting	86
1.2. Weed control methods	86
1.2.1. Physical weed control	86
1.2.1.1. Manual control	86
1.2.1.2. Mechanical control	86
1.2.2. Chemical weed control	87
1.2.2.1. Application	87
1.2.2.2. Manual control	87
1.2.2.3. Mechanical control	88
1.2.2.4. Aerial control	88
2. <i>Eucalyptus</i> coppice reduction	88
2.1. First coppice reduction	89
2.2. Second coppice reduction	89
2.3. Feathering	90
3. Pruning	90
3.1. Effects of live pruning	91
3.2. Tools	91
3.2.1. Handsaws	91
3.2.2. Mechanical saws	91
3.2.3. Edged tools	91
3.2.4. Pruning shears	91
3.2.5. Clubs	91
3.3. Corrective pruning – <i>Acacia</i>	91
3.4. Corrective pruning in relation to disease	92
4. Thinning	92
4.1. Management objectives	93
4.2. Marking for selective thinning	93
4.3. Thinning <i>acacia</i> stands	94
4.3.1. Naturally regenerated and direct seeding method	94
4.3.2. Planted stands	94
5. References	95

1. Weed control

Vegetation management is one of the most important factors influencing tree growth in young plantations as maximum crop production occurs in the absence of competing vegetation. This ensures that resources such as water, nutrients, light, and physical growing space are optimally available to the trees.² Weed control improves access for silvicultural operations, and has been proven to lead to uniform stands, facilitating a more accurate prediction of yield.

During the establishing period, regular weed control is carried out. It is even more critical during periods of water stress. These operations are normally timed to reduce the negative impacts of competing vegetation on tree performance. Negative impacts resulting from competition on tree performance are likely to be carried through to harvest. When trees “capture” the site in terms of shading by their crowns, it results in the almost total exclusion of any competitive vegetation during this stage.

Weed control should be timeous and implies: ²

- Competing vegetation is more susceptible to herbicides when young.
- The smaller size of the weeds ensures that most receive a complete cover spray.
- Lower herbicide application rates can be used, lowering the costs involved.
- Low vegetation height allows for spraying nozzles to be held lower, thereby reducing drift.
- Weeds will be controlled before they set seed.

1.1 Critical vegetation management interventions/phases

Weed control during a full rotation can be divided into three distinct phases, all of which have a direct bearing on the type and development of vegetation and therefore on the method of control.

1.1.1 Between harvesting and planting

Plantations should be managed so that land is seldom left in an unproductive state for any extended period. The site would have been prepared (pitted or ripped) before a pre-plant weeding operation and sufficient time allowed for weed flush in the disturbed areas. This is usually sprayed with a non-selective, broad-spectrum herbicide. A pre-harvest spray may be beneficial as it can reduce the need for a pre-plant spray.

When a pre-plant spray is applied the time between the application and the planting operation should be minimized so that maximum benefit is realized by the newly planted stand. The pre-plant spray is also a very effective method of controlling weeds as a full cover spray can be applied without fear of damaging young tree seedlings. In the event of re-establishing a previous *eucalyptus* crop, focus should be given to kill the regrowth from stumps (refer to Chapter 4 Land Clearing).

1.1.2 Between planting and canopy closure

This is the most critical phase in terms of vegetation management and any negative impact resulting from competition on tree performance is likely to be carried through to harvesting. It is common practise to treat all weeds (full cover spray) within the first growing year, and selective (spot spray) in the second, targeting woody and noxious weeds.

In the case of browsing damage of wattle seedlings by small antelope and goats, weedy compartments are, ironically, less susceptible to competition. It is suggested that the 1.2m ring/line be kept weed free with compromises made in the interrow.¹

The time to canopy closure varies between species and between localities. Canopy closure for *eucalyptus* and *acacia* can be achieved within one to two years, and for pine in three to four years depending on the locality. It is advisable to keep the 1.2m ring or line free of weeds during this period.

With fast-growing clones and the advent of low-drift nozzles complete weeding (both row and inter-row) should be achieved. Staff should be trained in the use of low-drift nozzles. This method can result in canopy closure within the first year and will maximize profit at the final crop.

1.1.3 Between canopy closure and harvesting

The ability of the trees to capture the site in terms of shading by their crowns results in the almost total exclusion of any competitive vegetation during this stage. The frequency and intensity of vegetation management during this phase is reduced and tends to precede thinning, pruning or harvesting operations to improve access. Effective weed control during this stage reduces the need for subsequent control operations before and after felling. Management during this phase becomes selective with perennial broadleaves and noxious weeds being targeted.

1.2 Weed control methods

Because of the environmental and human health risks associated with the use of chemicals, their use globally has been restricted. A strategy of Integrated Pest Management (IPM) is encouraged to limit the use of chemical pesticides, i.e., only after having considered all available weed management strategies, the use of chemicals may be identified as a suitable control method, and often in combination with other methods.

Weeds can be controlled by one or more, or a combination of the following methods:

1.2.1 Physical weed control

1.2.1.1 Manual control

Manual weed control is the removal of weeds by hoeing, slashing, or pulling out by hand, or even by grazing. When hoeing in wattle stands, beware of damage to the larger roots, as this may lead to gummosis (the formation of patches of a gummy substance)¹. Hoeing and slashing should be restricted to the 1.2m ring/line to reduce costs and minimise site impacts such as loss of topsoil. Refer Annexure 7.

1.2.1.2 Mechanical control (refer to Chapter 4 Land Clearing)

Mechanical weed control utilises tractor-drawn implements such as rotary slashers or hoes to either cut the weeds or to incorporate them into the soil. Mulching is another option – refer Photo 1.

Some factors to be taken into consideration would be:

- Access due to plantation residue from unburnt compartments.
- Close planting espacement preventing entry.
- Stumps from previous rotation restricting movement.



Photo 1: Mulching ³

Additional disadvantages associated with physical weed control methods are the disturbance of the soil leading to conditions conducive to the stimulation of seed germination, damage to the root systems, and soil compaction resulting from the use of tractors.

1.2.2 Chemical weed control (refer to Chapter 4 Land Clearing)

Herbicides that control certain species while leaving others unharmed are called selective herbicides, whereas non-selective herbicides kill any plant species and consequently its use should be considered with care. Herbicides applied to the soil to target either the root systems of existing plants or affect the germination of existing seeds, are the so-called pre-emergent herbicides.

Herbicides can have detrimental impacts on the natural environment, therefore their use is limited and controlled through legislation and certification. The Timber Industry Pesticide Working Group (TIPWG; <https://www.tipwg.co.za>) of Forestry South Africa (FSA®) screens appropriate chemicals for use in plantation forestry. TIPWG is an industry collaboration that assists with provision of technical support, provision of guidelines and enables compliance in the use of chemicals.

Staff handling and applying chemicals must complete a training course and are required to wear the appropriate personal protective equipment (PPE). Safety requirements must be adhered to for the storage and the handling of the chemicals.

1.2.2.1 Application

- Unless stated otherwise on the chemical label, chemicals should not be applied in windy conditions, in rain or when heavy rain is expected in an area, nor in extreme dry weather, frosted or snow conditions.
- Chemicals should not be applied in proximity of water courses, lakes, reservoirs, and open dams, unless specifically formulated for use by the manufacturer.
- Seedlings treated with insecticides shall not be soaked in watercourses, dams, vleis or any other natural water source.
- No chemical cocktails may be used other than that prescribed by the manufacturer.
- Application should be done strictly according to the directions on the label.

1.2.2.2 Manual control

Most post-emergence herbicides used in plantations are applied as a foliar application using knapsack sprayers. Manual chemical spray can be applied as full cover spray or spot spray, targeting the intended weeds only.



Photo 2: An innovative wind box for accurate spraying.⁵

1.2.2.3 Mechanical control

With the move to the mechanisation of silviculture operations, tractor-drawn boom sprayers are used to carry out pre-plant spraying. Spray rigs have also been adapted to allow workers to spray in post-plant weeding operations by walking behind the tractor holding a lance connected to the boom sprayer. This system does have advantages as the spraying pressure is kept constant. Productivity is higher than manual spraying as workers do not have heavy loads to carry or constantly refilling knapsacks.



Photo 3: An innovation by Mersey Trading used effectively for the control of bramble. ⁴

1.2.2.4 Aerial control (refer to Chapter 4 Land Clearing)

The use of aircraft to apply herbicides is a worthwhile alternative given the smaller cost associated with the large areas that can be done in a relatively small time. Effective pre-spray planning is necessary, and the operation is dependent on favourable weather conditions. The use of aircraft has been limited to pre-plant sprays. The pressure on environmental issues as well as the threat of drift to adjacent compartments and crops have contributed to this method not utilised often.

2. *Eucalyptus* coppice reduction

The preparation for coppice reduction commences with the harvesting of a compartment, as harvest planning should consider whether the compartment will be replanted or coppiced. For compartments to be coppiced, a stump height of between 10–15 cm above ground level should remain. Damage to stumps during extraction operations should be limited, i.e., the bark should remain intact around the stump. This will protect any dormant buds and reduce infections, stump mortality, and poor coppice growth. For this reason, extraction routes should be planned prior to harvesting operations.

With regards to *Eucalyptus nitens* (which often coppices poorly), the higher the remaining stump, the greater the number of epicormic buds available for regeneration. Coppicing of *E. nitens* should only be considered if there are sufficient live stumps (refer below) and the coppice regrowth is healthy, failing which it would be advisable to replant the area.

Coppice reduction should only be considered if the compartment has more than 1,100 live stumps per hectare. This will allow the stand to return to the original stocking of the planted stand by leaving additional stems per stump to compensate for dead stumps within the

compartment. In considering coppicing a compartment versus replanting, the following must be considered:

- Number of live stumps per hectare (minimum of 1,100).
- Consider the health of the entire compartment.
- Consider the number of times the compartment has been coppiced before and consider the benefits of the improved quality of seedlings which have been produced over the length of the previous rotation. These improved seedlings offer improved fibre yield providing a better mean annual increment (MAI) for the next rotation, if the area is replanted.
- Consider that costs per hectare of doing coppice reduction versus re-establishment and carrying these costs for a rotation length.
- Regardless of coppice or replanting, the best returns and growth on *eucalyptus* are achieved from a compartment that have had limited weed competition.

2.1 First coppice reduction

- Depending on the growth, the first reduction must be done when the coppice shoots are between 2 - 4m in height. These should be reduced to two or three shoots per stump.
- The reduction is best performed by means of a hatchet to reduce the damage to adjacent shoots. A cane knife has a wider blade and therefore cuts into adjacent shoots which could result in windfalls.
- Shoots should be cut as low as possible, preferably flush with the stump. This ensures improved callusing and less feathering on the cut shoots.
- The remaining shoots must be dominant, well spread around the stump, firmly attached and the lowest on the stump. To reduce the risk of windfalls, shoots should preferably be on the windward side of the stump, especially on exposed sites. They should be well matched in height, have a straight form and the difference in their diameter should be less than 1 cm.
- Although it is best to do coppice reduction during the winter months, try to avoid doing work in exposed sites during July/August where berg winds could damage the thinned stand and blow the newly thinned coppice over.

2.2 Second coppice reduction

- The number of shoots should not exceed the original compartment stocking; therefore, two or one shoot per stump is left once the shoots are 6–7m in height.
- A good method to ensure the correct stocking is to assess a “box” of 3 lines by 3 trees. In each box of 9 stumps or “planting stations”, 9 shoots must remain (Figure 1).

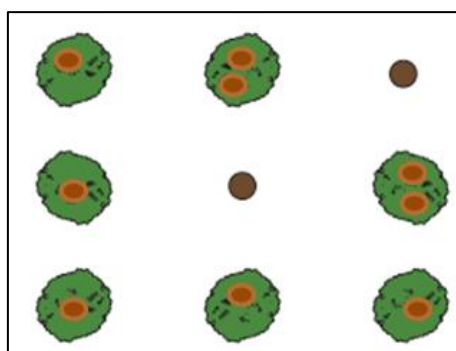

Figure 1: In a box of 9 planting stations ( or ), leave 9 shoots  .

- If more than one shoot per stump is required to fill gaps (as a result of dead stumps), select the larger diameter stumps adjacent to the gap. This will ensure adequate stocking.
- Leave two shoots per stump for stumps which occur along the compartment boundary, and along internal roads where trees are exposed to more light.

2.3 Feathering

- After the first and second coppice reductions new growth may appear around the base of the stump. This feathering is best controlled with a glyphosate spray when the feathering is at knee height. Using a chemical seems counter-intuitive but is more effective than using a hatchet which often cause damage to the coppice shoots. Feathering should not be allowed to grow more than 0.5m in height.
- Uncontrolled feathering reduces the growth of the selected stems due to hormones produced by feathering.
- Coppice dominance and the shading effect from the coppice will reduce the re-occurrence of feathering.

3. Pruning

Branches form knots which are a common defect of timber - especially those knots formed by dead branches. The lateral grain distortion around knots leads to reduced timber strength. Live knots are harder, denser, and often contain more resin than the wood. Shrinkage is different to that of the surrounding tissue. Knots contain compressed wood which spread into the stems at volumes three to five times the knot volume. During mechanical pulping, knots powder instead of breaking down into fibres, resulting in decreased pulp yield. Resinous knots produce pulp of undesirable colour, requiring more bleaching chemicals.

Natural or self-pruning of pines is generally much slower than that of *eucalyptus*. Complete freedom from grain distortion is only achieved after the first 3 or 4 cm of new wood. The sooner pruning commences, and the longer the rotation of the crop, the higher will be the proportion of knot-free timber.

Pruning regimes are largely determined by the intended market. The most intensive regimes are applied to timber intended for the sawlog and pole markets, while for the pulp markets pruning is limited to facilitating access.

The objectives of pruning are to:

- improve timber quality, i.e., to prevent the formation of dead (loose) knots, produce clear timber and reduce the size of live (sound) knots. The aim with saw timber is to limit the “knotty core” to 15 cm and to have a radius of at least 10 cm knot-free timber added after the pruning operation to justify it economically.
- facilitate movement in stands for other operations, e.g., marking for thinning.
- facilitate extraction.
- control fires, pests, and diseases.
- reduce fire hazards, for example creating vertical fire breaks.

3.1 Effects of live pruning

Properly conducted pruning is not harmful to the tree provided that:

- pruning cuts must be made flush with the tree trunk (not applicable to *Acacia mearnsii*).
- broken stubs must be removed.
- the surrounding bark must stay intact.
- cambium should not be damaged as this will lead to formation of resin pockets.
- correct tools are used.
- pruning is done during winter months to avoid secondary pathogen infections.

It is recommended that pruning should never exceed the removal of more than 50% of the live crown, as this will cause temporary increment reductions. Pruning up to 25% of the living crown will not affect increment and pruning to 70% causes longer lasting increment problems.

3.2 Tools

3.2.1 Hand saws

This is the most used type of equipment for pruning. Various types and configurations are available which can be applied depending on the application. Handsaws are safe, fast, effective and enable pruning closer to the stem than is possible with other tools.

3.2.2 Mechanical saws

These are mainly small chainsaws with an associated fast cutting action. Relative high costs are associated with the purchase of chainsaws, running costs, additional protective clothing, and the training requirements of operators. Damage to cambium can be a problem and operators must take care.

3.2.3 Edged tools

This comprises axes and slashers. Given the tools are sufficiently sharp and the labour suitably trained, this method would be second choice to hand saws. It is however dangerous working with these tools. Damage to cambium can be severe if the labour is not suitably trained.

3.2.4 Pruning shears

These tools are also used but leave longer stubs. Productivity is generally low, and this is not the preferred method. It is however advisable where thinner branches are being pruned which do not offer much resistance to hand saws and edged tools. These tools are widely used for *acacia* corrective pruning.

3.2.5 Clubs

These are used to remove dead branches from *eucalyptus* trees but is not a recommended method.

3.3 Corrective pruning – *Acacia*

Some wattle trees tend to produce multiple leaders or may fork as a result of damage to the apical bud or to the leader stems by insects, browsers, wind, hail, or snow. As the tree grows, the weight of the foliage on the limbs of the fork increases and splitting often occurs during windy conditions. Such splitting often occurs at a later stage, when all the branches

sappi

below the fork have died due to shading, and ultimately results in the whole tree dying. There may be leaders (below the break), but they will be deformed, and the growth rate will be impaired.

Corrective pruning must therefore occur to remove the weaker leaders during the first two years, before the height of the tree makes it impractical and costly. It is common with black wattle to have two or more shoots coming vertically out at the base and if unchecked these could compete with the leader. Such shoots hinder the development of the main stem and should be removed before they are 2.5 cm thick.

Early browsing damage normally does not require corrective pruning as a natural leader arises. When browsing damage occurs at a height of 0.6 m or more, corrective pruning should be performed.

The removal of living branches alters the growth of the tree temporarily due to the removal of foliage, altering the rate of photosynthesis. Live pruning should be restricted to correct forking and the removal of basal shoots only. Lateral shoots should never be removed unless they are interfering with access.¹

3.4 Corrective pruning in relation to disease - *Acacia*

The cut ends of shoots produced during pruning operations can serve as a source of entry for disease and the following precautions should be adhered to:

- Pruning should be limited to winter months.
- Limit pruning to absolute necessity (stem malformations, forking and hazardous stem side branches).
- A stub of 15 cm should remain.



4. Thinning

Artificial thinning is the removal of a proportion of individual living trees from a stand before clear felling. It is generally understood to take place after the onset of competition. However, pre-commercial thinnings or respacing may take place when trees start to compete. This implies that the initial planting espacement has made provision for quick canopy closure and having enough stems to select from.

The major objectives of thinning are to:

- provide remaining trees with more space for crown and root development, encouraging increment of the stem diameter and thus reaching the desired volume sooner.
- remove trees of poor form.
- prevent severe stress, which may induce pests, diseases and stand instability.
- provide an intermediate financial return from the sale of thinnings.

4.1 Management objectives

Thinning regimes are determined by the intended market. To produce pulp and mining timber, volume production in a stand must be maximised, i.e., no thinning or only a light thinning is required. To produce saw timber, veneer, and poles, heavy thinnings are required to produce a final crop of trees which meet the market requirements. There are two main types of thinnings practised, selective and non-selective thinnings.

Selective thinnings are carried out where the final crop is required to meet a required quality standard for saw timber or poles, and trees of poor form are removed. Non-selective thinnings are used when the stand density is reduced by felling whole rows i.e., every third row is felled to achieve a 33% reduction.

The Sirex wasp attacks stressed pine trees which creates an ideal habitat for their life cycle. By thinning these stands as an objective for saw timber, competitive stress between trees within the same stand is reduced, making them less prone to attack by Sirex. E.g. reduce the stocking by 30% or up to 1,000 stems per hectare by using selective thinnings at an age of eight years, before the onset of competition. Priority should be given to better sites because trees compete earlier due to the faster growth, making them vulnerable to Sirex infestations. Each fifteenth row can be felled to aid the harvesting operation.

4.2 Marking for selective thinning

This operation is extremely important and must be done by competent staff. The marking should be checked at frequent intervals. A deviation of up to 10% of the prescribed stems per hectare (spha) is generally acceptable. The following decision criteria should apply, listed in priority:²

- Firstly, look for defective and diseased trees.
- Secondly, look for trees below average size.
- Thirdly, an even distribution of remaining trees must be maintained.

Plots are laid throughout the compartment, generally 20m x 20m, which gives a plot area of 400m². The trees in the plot are counted and then certain trees are selected to reduce the stocking to the required level. To reduce to 1000 stems per hectare (spha), 40 trees must remain per plot. The trees selected to be removed are marked with paint. The compartment should be checked before harvesting to ensure that the marking was done correctly.

4.3 Thinning *acacia* stands

Acacia stands are generally established at a high initial spha. To ensure the production of trees large enough to produce good bark and timber in rotations of eight to twelve years, it is necessary that these high initial densities be reduced by successive thinning operations.

Wattle is grown both for its bark and timber and therefore thinning may be adjusted to favour either the quality or quantity of bark and/or timber. Bark quality is determined by the thickness of the bark, which usually correlates with stem diameter. Relatively heavy thinnings are done to ensure a greater stem diameter in the final crop.

When bark is the primary product and timber the secondary product, thinnings should begin early and successive thinnings should be well timed to avoid suppression and prevent rapid growth. Un-thinned stands produce a higher number of diseased trees as well as higher suppression, which affects the stripability of the bark and results in a reduction of utilisable timber.

Thinning regimes differ depending on whether stands were established by the natural regenerated/direct sowing method or planted.

4.3.1 Naturally regenerated and direct seeding method

When the average height of the seedlings is 20-30 cm a combination of weeding and spacing is done. Trees are spaced 0.6m apart and the first selective thinning is done when the average height is 2m. This results in the trees being spaced 1.2m apart and gives a stand density of 3,000 trees/ha. This thinning is mainly to remove any diseased, damaged, deformed, or suppressed trees.

The second thinning is done when the stand is approximately 4.0m high and the density after thinning is approximately 2,000 trees/ha. The final thinning is done when the trees are an average height of 7m with a density of 1,500 trees/ha after thinning on medium quality sites, 1,650 trees/ha on good quality sites, and 1,350 trees/ha on poor quality sites.

4.3.2 Planted stands

Two or more thinnings are required in plantations established with seedlings. When the initial density is 2,222 trees/ha, two thinnings are planned. The first thinning is done when the average height of the trees is 4m and the stand is reduced to a density of 2,000 trees/ha.

The second thinning is done when the trees are 7m tall and the stand is reduced to 1,500 trees/ha, or less if on a poor site (refer stocking densities in Table 1). A 10m rope is used when marking trees for thinnings. The rope is pulled between two rows creating a 60m² plot of 10m x 6m (for a 3m row spacing) and trees are marked to leave the required number of trees along the rope.

Age in years	Height	Operation	Stocking	Espacement	
0		Seedlings	2,222	3m x 1.5m	
			Site Quality		
			i	ii	iii
± 2	4m	1st thinning	2,000	1,900	1,800
		Method: use 10m rope between 2 rows and leave:	12	11	10
3-4	7m	2nd thinning	1,650	1,500	1,350
		Method: use 10m rope between 2 rows and leave:	10	9	8

Table 1: Stocking densities.

5. References

- ¹ Dunlop, RW (2002) Black Wattle: The South African Research Experience. Wattle Handbook Chapter 1 Introduction. Institute for Commercial Forestry Research, Pietermaritzburg, South Africa.
- ² South African Forestry Handbook (2002) Vol. I and 2. Southern African Institute of Forestry.
- ³ Photo by J Jansen.
- ⁴ Photo by T Coetzer.
- ⁵ Photo from <https://saforestryonline.co.za/>

CHAPTER 9 - FIRE PROTECTION	Page
1. Fire prevention	96
2. Fire protection	97
2.1. Pre-fire season preparation checklist	97
2.2. Fire equipment check	97
2.3. Fire breaks	97
2.3.1. Preparation of fire breaks	98
2.3.2. Fire break burning	98
2.4. Fuel load management	99
2.5. Fuel load management tools	100
2.6. Fire crews	100
2.7. Communication	100
2.8. Water filling points	100
2.9. High danger zones	100
2.10. Lookouts/camera systems	101
2.11. Fire danger index	101
2.12. Firefighting equipment	104
2.13. Aerial firefighting associations	104
2.14. Insurance	104
3. Fire suppression	104
4. Mopping up	104
5. References	107

Wild or uncontrolled fires are a risk to life, property, and the environment. Without preventative measures, veldfires will continue to burn for as long as the weather is favourable and there is vegetation to burn. Forest management contributes to conditions which reduce the risk of uncontrolled fires and limits the extent of their damage.

Landowners are responsible to manage fire risks and to control fires on their property. The National Veld and Forest Fire Act 101 of 1998 (hereafter referred to as the Act) is applicable to all landowners, not plantation owners only. The landowner should be a member of the local Fire Protection Association (FPA). Fire management consists of three elements – prevention, protection, and suppression.

1. Fire prevention

The first step is to assess the risk of fires. The following are examples of aspects that influence fire risk: community relations, road density and maintenance, and the management of residue, open areas, and alien plant control. All possible risks must be listed, such as power lines, high fuel loads, charcoal kilns, arson, beehive theft or inadequate communication systems. These are then analysed, followed by a rating of these risks as high, medium, or low.

The next step is to compile preventative actions to deal with or mitigate each risk. A fire management plan should be prepared and implemented in a manner that provides protection of infrastructure, plantations, and other sensitive features as well as to meet the requirements of the law.²

2. Fire protection

This is the process of protecting assets against uncontrolled fires. The Act stipulates the responsibilities of people in control of land:

- prepare firebreaks on their side of the boundary if there is a reasonable risk of veldfire.
- have the necessary equipment, protective clothing, and trained personnel for extinguishing fires.
- do everything in their power to stop the spread of the fire.

2.1 Pre-fire season preparation checklist

- Fire insurance paid up.
- Fire equipment serviced and checked (refer 2.2).
- Staff refresher training.
- Standby duties arranged.
- Road maintenance.
- Confirming with neighbours:
 - burning of external fire breaks.
 - availability of fire equipment.

2.2 Fire equipment check ³

- Condition of all knapsacks: are they working e.g., no leaks, straps ok?
- Condition of all rakes – sharp, no loose or broken handles.
- Condition of all beaters – no loose or broken handles.
- Condition of drip torches – no leaks – drip torch fuel available?
- Watercart – pumps working, no leaks, condition of starter rope, fuel, extra fuel available?
- Hose reels in working condition.
- Roll out all hoses: check no leaks; all Geeka couplings are compatible?
- Lorry/tractor starts and works, has been serviced and greased.
- Crew has been trained and knows how to operate all tools and pumps listed above.
- Equipment is capable of sucking water, or preferably, overhead tanks or mobile suction pumps are available.
- Communications – radios/cell phones (important for radios to have the correct channels for communication with aircraft).

2.3 Fire breaks

- The Act doesn't specify requirements for fire breaks. This is because requirements will vary from one area to the next. Local practice and issues should determine these.
- The Act states that the landowner must pay attention to weather, climate, terrain, and vegetation in deciding on how to prepare the breaks.
- The fire break must:
 - be wide enough and long enough to have a reasonable chance of stopping the veldfire.
 - not cause soil erosion.
 - be reasonably free of flammable material.

2.3.1 Preparation of fire breaks

- Prepare a tracer in advance on the perimeter of the fire break.
- Tracers can be graded, hoed, chemical treated or disked (see Photo 1). Tracer belts are normally between 2 and 3m wide.
- Chemically prepared tracers must be burned after the treatment to create a clean strip.

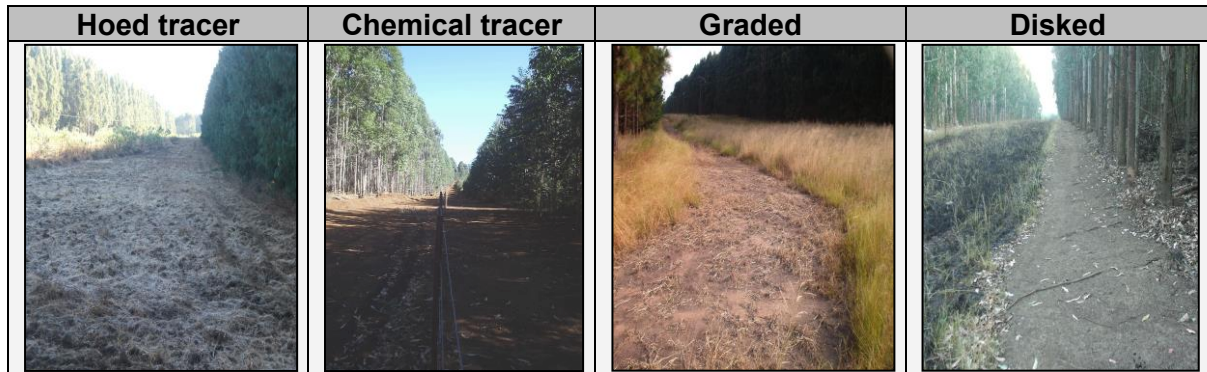

Photo 1: Types of tracer preparation

2.3.2 Fire break burning

Burning of fire breaks must be done within set parameters to reduce risk. Table 1 provides an example of a checklist. Obtain permission from the local FPA and inform neighbours beforehand.



BURNING OPERATING PROCEDURES CHECKLIST										COMPLIES	
										Yes	No
1. If the firebreak is on a boundary , ensure that the relevant neighbour(s) have been notified. The neighbour or his authorised representative should be present when burning a boundary break.											
2. Ensure all relevant stakeholders are notified before commencing with the burning operations.											
3. Ensure that proper radio communications are in place. If not, ensure compliance with the “dead communication spots” action plan.											
4. Burning shall only be undertaken when approved by the local FPA.											
5. Ensure that all the tracers are to the required standard before commencing burning.											
6. Ensure a minimum additional 50% of resources are available immediately if required.											
7. When burning, the Fire Danger Index (FDI – refer 2.11) shall be measured infield (and recorded) every hour, or as soon as the weather conditions start changing. Stop burning when the FDI exceeds permissible limits!											
8. Always ensure that sufficient resources are in place for guarding and mopping up the rear.											
9. After completion of the burning operations, ensure that the burned area is properly mopped-up before leaving the area. If in any doubt, leave sufficient resources to guard the burnt area!											
10. Notify all relevant stakeholders when the burning is completed.											
FDI Readings											
Time	RH	Temp	Wind Speed	FDI	Time	RH	Temp	Wind Speed	FDI		
Signature of person in charge								Date			

Table 1: Fire break burning checklist.¹

2.4 Fuel load management

Fire needs oxygen, fuel, and heat to burn. In the process of growing trees, fuel is added to the forest floor which contributes to the intensity of any fires which may occur. The more intense the fire is, the more difficult it is to contain and the greater the damage to the growing crop.

The critical success factor is to create low fuel load zones inside the plantation from which uncontrolled fires can be contained. Fuel load management is the best tool to reduce the risk inside a plantation. To understand the risk of high fuel loads it is necessary to do a fuel load classification for each compartment. Based on this classification an assessment can be

done to update the fire management plan to address the high-risk areas. This must be done annually.

2.5 Fuel load management tools

To reduce the build-up of fuels inside a plantation it is important to burn or mulch harvesting residue after harvesting, and to keep compartments weed free until canopy closure.

Coppice and pruning operations create plantation residue, which increase fuel loads. The fuel loads can be reduced by selling droppers out of coppice residue. Residue can be mulched or rotary slashed. Keep compartments weed free to ensure low fuel loads. Grazing of natural areas and compartments older than three years will reduce fuel loads.

2.6 Fire crews

Both section 17 of the Act, and the Occupational Health and Safety Act, require an owner to have trained personnel for extinguishing veldfires. Regulations under the latter Act provide minimum standards for protective clothing and training of firefighters.

The local FPA will specify any other minimum requirements. People younger than 16 and older than 60 are not allowed to be involved in firefighting.

2.7 Communication

The ability to communicate with all role players in the firefighting process is critical.

2.8 Water filling points

The availability of water during the firefighting process is crucial. Water filling points throughout the property will reduce refilling time, therefore increasing the availability of water. These points can be:

- dams.
- river crossings with an available suction point.
- overhead pipes (hydrants).
- overhead tanks.
- pump facilities (borehole/dam).

2.9 High danger zones

Large volumes of combustible material need to be identified and additional preventative measures are required. High concentrations of mature plantations in one specific area should be isolated to reduce financial loss. This can be done by clearing all roads and routes of combustible materials. The compartments can be divided into 5-hectare sections by clearing certain interrows, but this may be a costly exercise. During high fire index periods these areas should be patrolled more often.

2.10 Lookouts/camera systems

Fire detections systems on a 24-hour basis are essential for any timber plantation. Lookouts are situated on predetermined vantage points for the maximum cover of a plantation. The lookouts are normally shared by different plantation owners and the lookouts are in contact with all the different landowners. The shared detection lookouts became more advanced in the late 1990s when digital camera systems replaced the manned lookout towers.

2.11 Fire danger index (FDI)¹

The local FPA will have standard operating procedures and regulations during high FDI periods.



Indicative colour	BLUE	GREEN	YELLOW	ORANGE	RED
Danger rating	Insignificant	Low	Moderate	High	High - Extreme
Fire prevention & preparedness measures	No precaution is needed.	Fires including prescribed burns may be lit, used, or maintained in the open air on the condition that persons making fires take reasonable precautions against the fires spreading.	No fires may be allowed in the open air except those that are authorised by the Fire Protection Officer where a FPA exists, or elsewhere, the Chief Fire Officer of the local fire service, or fires in designated fireplaces.	No fires may be allowed under any circumstances in the open air.	No fires may be allowed under any circumstances in the open air and FPA's and municipal Disaster Management Centres must invoke contingency fire emergency and disaster management plans including extraordinary readiness and response plans. All operations likely to ignite fires halted. Households placed on alert.
Fire behaviour	Fires are not likely to ignite. If they do, they are likely to go out without suppression action. There is little flaming combustion. Flame lengths in grassland and plantation forest litter lower than 0.5 m and rates of forward spread less than 0.15 km/h.	Fires likely to ignite readily but spread slowly. Flame lengths in grassland and plantation forest litter lower than 1.0 m and rates of forward spread less than 0.3 km/h.	Fires ignite readily and spread rapidly, burning in the surface layers below trees. Flame lengths in grasslands and plantation forests between 1 and 2m, and rates of forward spread between 0.3 and 1.5 km/h.	Fires ignite readily and spread very rapidly, with local crowning and short-range spotting. Flame lengths between 2 and 5 m, and rates of forward spread between 1.5 and 2.0 km/h.	Conflagrations are likely in plantation forests, stands of alien invasive trees and shrubs, sugar cane plantations, and fynbos. Long range fire spotting is likely in these fuel types. Rates of forward spread of head fires can exceed 4.0 km/h and flame lengths will be in the order of 5 to 15 m or more.

<p>Fire suppression difficulty</p>	<p>Direct attack feasible: one or a few field crew members with basic firefighting tools easily suppresses any fire that may occur.</p>	<p>Direct attack feasible: fires safely approached on foot. Suppression is readily achieved by direct manual attack methods.</p>	<p>Direct attack constrained: fires not safe to approach on foot for more than very short periods. Best forms of control should combine water tankers and back burning from fire control lines.</p>	<p>Direct attack not feasible: fires cannot be approached at all and back burning, combined with aerial support are the only effective means to combat fires. Equipment such as water tankers should concentrate efforts on the protection of houses.</p>	<p>Any form of fire control is likely to be precluded until the weather changes. Back burning dangerous and best avoided.</p>
---	---	--	---	---	---

Table 2: Fire danger index.¹

2.12 Firefighting equipment

It is a requirement of the Act that each landowner must have adequate firefighting equipment. Equipment requirements should be proportional to the risk and is influenced by assistance from neighbours and firefighting associations. The local FPA should have minimum requirements, as well as agreements between neighbours for assistance during wildfire events.

Standard or minimum equipment will be:

- quick reaction unit (with a “*bakkie sakkie*”).
- water tanker (truck or tractor drawn).
- rake hoes.
- fire beaters.
- knapsack sprayers.

2.13 Aerial firefighting associations

Aerial firefighting associations have been part of forestry for several years. The decision by the landowner to join the association and share in the benefit of this quick reaction unit is voluntary. Since 2001, insurance companies require landowners to be active members of the associations in order to qualify for insurance and discounts.

2.14 Insurance

Many private growers have converted from mixed farming practices to pure timber farms and their total income depends on their timber crop. It is for this reason important to ensure timber based on the value of the timber, and this should be done annually to ensure adequate cover.

3. Fire suppression

Suppression includes all the actions to contain and to extinguish a fire. Pre-suppression planning is critical to ensure early detection, quick response, and a well-organized suppression operation.

Each FPA area will have a Standard Operating Procedure for high fire danger days. These operating procedures set certain standards to which all landowners must conform, in order to ensure that crews are ready for any call outs. The local FPA assists with planning during a high danger day, provides landowners with weather information and any other support needed. Working together during fire suppression activities is critical.

4. Mopping up ¹

As soon as the burning operations start, the real work begins: “MOPPING UP”!

General procedure

Always have a small team available right from the start to guard the rear (completed section of the burn) and start mopping up as soon as a section has been burned and continue following up as the burn progresses. This unit should consist of a *bakkie-sakkie* or strike unit on smaller burns, and a fire tender in the case of larger/slash burns with a few trained labourers, depending on the size of the burn. The mop-up unit should always attempt to keep up with the pace of the burning crew, however, only move forward if the section is 100% safe, and if not, slow down the burning process!

Start mopping-up as soon as a section of the burn has been completed

Work from the fire control line toward the centre of the fire. On larger burns, such as large open areas or slash compartments, mop-up a minimum of 30m, or to such a distance that nothing will blow, roll, or spot across the line.

Secure and extinguish burning materials

Arrange burning fuels so that it cannot roll across the fire control line or bank the line in steep areas to catch rolling debris - refer to the drawing below. Spread smouldering fuels and apply water. Scatter fuel away from the line. Open stumps and roll over logs and ensure it is completely extinguished.



Reinforce the fire control line

Widen and clean the fire control line next to problem areas. Dig the fire control line down to bare earth. The line must be banked in steep areas to catch rolling debris (refer to the drawing above). Burn out islands (unburned sections). Dig out dead or burning roots that cross under the

fire line. Feel for hot material along the fire line – it is recommended to make use of a heat detection device such as a Knox scanner. Ensure that this line is properly anchored on both ends.		
Check for spot fires		
Constantly check for spot fires, especially downwind from the fire line. Check heavier fuels (logs, snags, slash, etc.) for smouldering material.		
Mopping-up tools & equipment		
Rake hoes	Buckets	
Knapsack pumps	High volume hose (38mm lay flat)	
Hatchets	Heat sensor	
Mopping-up procedures		
<ul style="list-style-type: none"> • Construct a hand line by removing combustible material away from the fire perimeter according to the required standard. • Wet hot spots next to the hand tracer line. • Widen hand line to the required width and open into the mineral soils. • Steep terrain? Then construct trenches in hand lines to prevent burning material crossing the hand line. • Remove all burned stumps or branches 20m away from the hand line into the burnt area. • Use a heat sensor to identify hot spots in the 1st 20m perimeter around fire. • Extinguish these identified hot spots by wetting. • Hot spots must be opened with a rake hoe and wetted until no heat is detected. • Chip away burning sections of stumps with a hatchet and wet properly. • Drench burning or smouldering pieces into a bucket of water to extinguish properly. • Scan the 20m perimeter again with the heat sensor and treat any hot spots in this area. • The forester must declare the perimeter safe. • Treat the second 20m perimeter. 		
Mopping-up techniques		
Construction of hand line	Manually construct a line with rake hoes to the required width. Keep the line close to the fire line and as straight as possible.	Rake hoes
Wetting of burning material	Use a hose or knapsack sprayers to wet all burning stumps, roots, and hot spots. Turn logs over and wet the underside.	Rake hoes and water
Burning stumps	Chip burned sections away and wet these.	Hatchets
Inspection	Check with heat sensors to ensure to all hot spots are treated.	Heat sensor
Burning logs	Drag burnt logs and other material at least 20 m into the burnt area.	Rake hoes/drag forks

Table 3: Mopping up.

5. References

- ¹ Sappi Forests Risk Management System (adapted).
- ² Environmental Guidelines for Commercial Forestry Plantations in South Africa (2021) 4th edition. Forestry South Africa. <https://www.forestrysouthafrica.co.za/2021-environmental-guidelines/>
- ³ D Deppe, personal communication.



sappi

CHAPTER 10 - DISEASES AND PESTS	Page
1. Introduction	109
2. Diseases of eucalypts, wattle, and pines	111
2.1. Foliar diseases	111
2.1.1. Destructans leaf blight	111
2.1.2. Wattle rust	113
2.1.3. Elsinoë shoot and leaf disease	115
2.2. Stem/branch diseases	117
2.2.1. Botryosphaeria canker	117
2.2.2. Coniothyrium stem canker	119
2.2.3. Diplodia canker/die-back/blue stain	121
2.2.4. Pitch canker	123
2.3. Wilt and root diseases	125
2.3.1. Bacterial wilt	125
2.3.2. Ceratocystis wilt	127
2.3.3. Phytophthora root rot	129
2.3.4. Rhizina root rot	131
3. Pests of eucalypts, wattle, and pines	133
3.1. Foliar pests	133
3.1.1 Gonipterus snout beetle	133
3.1.2 Leptocybe gall wasp	135
3.1.3 Pine brown tail moth	137
3.1.4 Pine emperor moth	139
3.1.5 Wattle bagworm	141
3.1.6 Wattle mirid	143
3.2 Stem pests	145
3.2.1 Cossid moth	145
3.2.2 Deodar weevil	147
3.2.3 Long-horned beetles	149
3.2.4 Sirex wood wasp	151
3.3 Root and establishment pests	153
3.3.1 Cutworm	153
3.3.2 White grub	155
3.4 Other pests	157
3.5 Damage-causing animals	158

1. INTRODUCTION

This chapter deals with the major diseases and pests of commercial forestry trees in South Africa. It only highlights some of the most common/destructive ones under plantation conditions and does not include nursery pests/pathogens. Not all these pests and diseases result in tree death. However, losses due to reduced growth and yield, especially over multiple seasons, often have an equally or even more significant negative impact on economic gain.

The management of pests and diseases should be achieved using an Integrated Pest Management (IPM) strategy (<https://www.tipwg.co.za/integrated-pest-management/>). This is a more sustainable and durable management strategy and in line with forest certification requirements. IPM relies on a combination of techniques to minimize the incidence and impact of pests and diseases with the least environmental, social, and economic costs possible.

sappi

This includes the use of:

- biological control agents, e.g., predators and parasitoids.
- bio-pesticides (pesticides derived from natural materials).
- chemical ecology, e.g., pheromones (mating disruption, surveillance). Research by the Tree Protection Cooperative Programme (TPCP) at the University of Pretoria led to the first commercial application of a sex pheromone to manage an insect pest, *Coryphodema tristis* (cossid moth), in plantation forestry.
- land management, e.g., site species matching and sound silvicultural practices.
- breeding and selection of pest and disease tolerant and/or resistant tree genotypes.
- synthetic chemicals. Ideally, insecticides and fungicides should only be used as a short-term solution and where it can have most significant economic impact. They are not very target specific and may affect biological control agents and pest predators if these are present.

Developing effective pest and disease management tools requires large amounts of data, in order to develop prediction tools and match the most appropriate control strategy/biological control agent with the pest/pathogen. To obtain this data, participation and input from all forestry stakeholders is required. Farmers and foresters are, therefore, encouraged to report pest and disease incidence to either a Sappi representative, the Sappi Pests and Diseases Programme or the Tree Protection Co-operative Programme (TPCP), Forestry and Agricultural Biotechnology Institute (FABI), at the University of Pretoria (<https://www.fabinet.up.ac.za/>).

For a more comprehensive list of plantation pests and diseases consult the South African Forestry Handbook, 5th Edition (Southern African Institute of Forestry (SAIF)) or contact the Sappi Pests and Diseases Programme (Research, Planning and Nurseries).



(With permission)

2. DISEASES OF EUCALYPTS, WATTLE AND PINE

2.1 Foliar diseases

2.1.1 *Destructans* leaf blight

Causal agent: *Teratosphaeria destructans*

Hosts: *Eucalyptus* species and varieties, including GU, GN, GC. Also observed on *E. dunnii*, but at low levels (single leaves). Considerable variation has been seen between different varieties and species of eucalypts.

Damage: Leaf spot, blight, shoot die-back. Severe infections may result in tree death, as observed in Indonesia and other tropical regions. This has not been observed in South Africa yet. Highly susceptible varieties in South Africa are stunted and have bad growth forms (rounded canopies with no apical dominance). Defoliation and reduced tree growth results in delayed canopy closure and results in the need for additional weeding operations.

Biology: The pathogen requires high relative humidity for spore germination and infection. Spores are spread via rain splash and wind. In contrast to *T. epicoccoides*, the *destructans* blight pathogen preferentially infects the young, soft leaf and shoot tissues. Although stated to be a tropical disease, the disease in South Africa also occurs in temperate regions, e.g., the Lothair and Amsterdam regions and KZN Midlands, especially in mist belt areas.

Symptoms: Chlorotic (yellow) to red blotches/spots on leaves (Figure 1A, B). Black spore masses may be found on the underside of leaves (Figure 1C). Spots/blotches may have red and/or corky margins depending on the tree variety infected. Leaves may become distorted and completely discoloured (Figure 1D, E). In severe cases leaves and shoot tips die (Figure 1E, F).

Management: Selection and breeding of tolerant/resistant varieties have resulted in significant reduction of the impact of this disease.

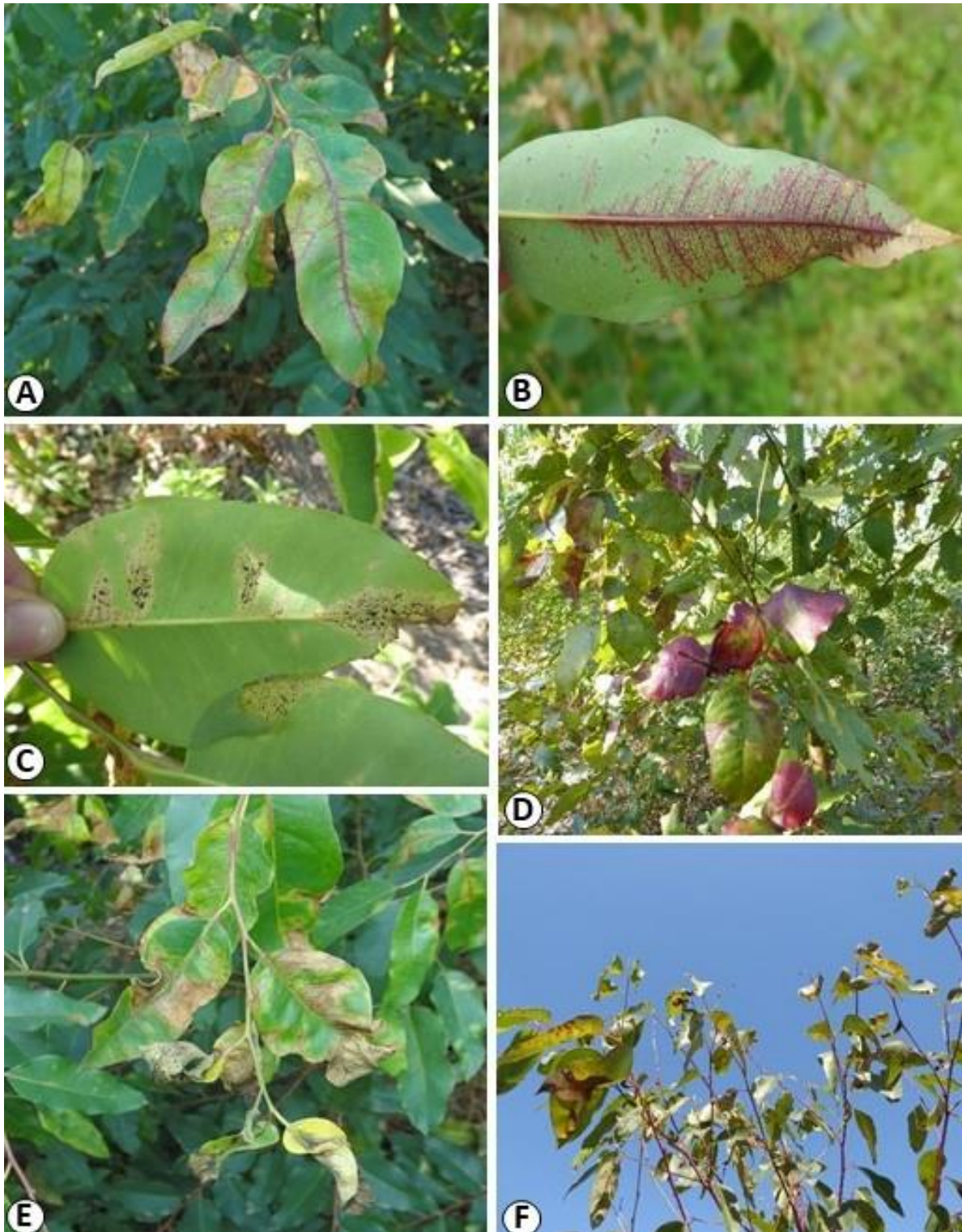

Figure 1. Destructans leaf blight symptoms on eucalypts. (A, B) Chlorotic (yellow) to red blotches/spots on leaves, (C) Black spore masses may be found on the underside of leaves, (D, E) Leaves may become distorted and completely discoloured, (E, F) In severe cases leaves and shoot tips die.

sappi

2.1.2 Wattle rust

Causal agent: *Uromycladium acaciae*

Hosts: *Acacia mearnsii* most affected, but also found on *A. decurrens* to a lesser extent.

Damage: Causes pinnule spots and leaf drop. In severe infections it may also affect the branches and even main stems of young trees resulting in tree malformation and stunting. Young seedlings (younger than 6 months) may be killed by the disease. Growth of older trees may be significantly impacted. Growth losses of between 20 and 40% have been reported as a result of wattle rust in South Africa.

Biology: *Uromycladium acaciae* requires high relative humidity and water for spore germination and infection (periods of 12h or longer is optimal). It is therefore most common in areas prone to mist. Disease development is most severe during summer months. Two lineages of the pathogen have been found in South Africa, one which infects and causes damage to younger plant tissues and one that mostly affects older tissues. The former is the most damaging stage and the one which has been causing disease in South Africa since 2013.

Symptoms: In severe cases complete defoliation and malformation of stems and branches may occur (Figure 2A). Some symptoms are visible as small yellow spots on pinnules, often with the presence of fungal spores in the spots (Figure 2B). Infestation may develop into pinnule drop (Figure 2C). Under moist conditions slimy masses of brown spores (telia) accumulate on leaves and branches (Figure 2D), when dry, powdery brown masses of spores can be found on lesions on the leaves, petioles, and stems (Figure 2E). Lesions, with or without spores may also be found on the green stems of younger trees (Figure 2F).

Management: Some success has been achieved with timely application of fungicides. Two fungicides have been specifically registered for use against the disease in South Africa. Significant success has also been achieved by the Institute for Commercial Forestry Research (ICFR) and forestry partners in selection and breeding of disease tolerant genotypes which are propagated as cuttings.

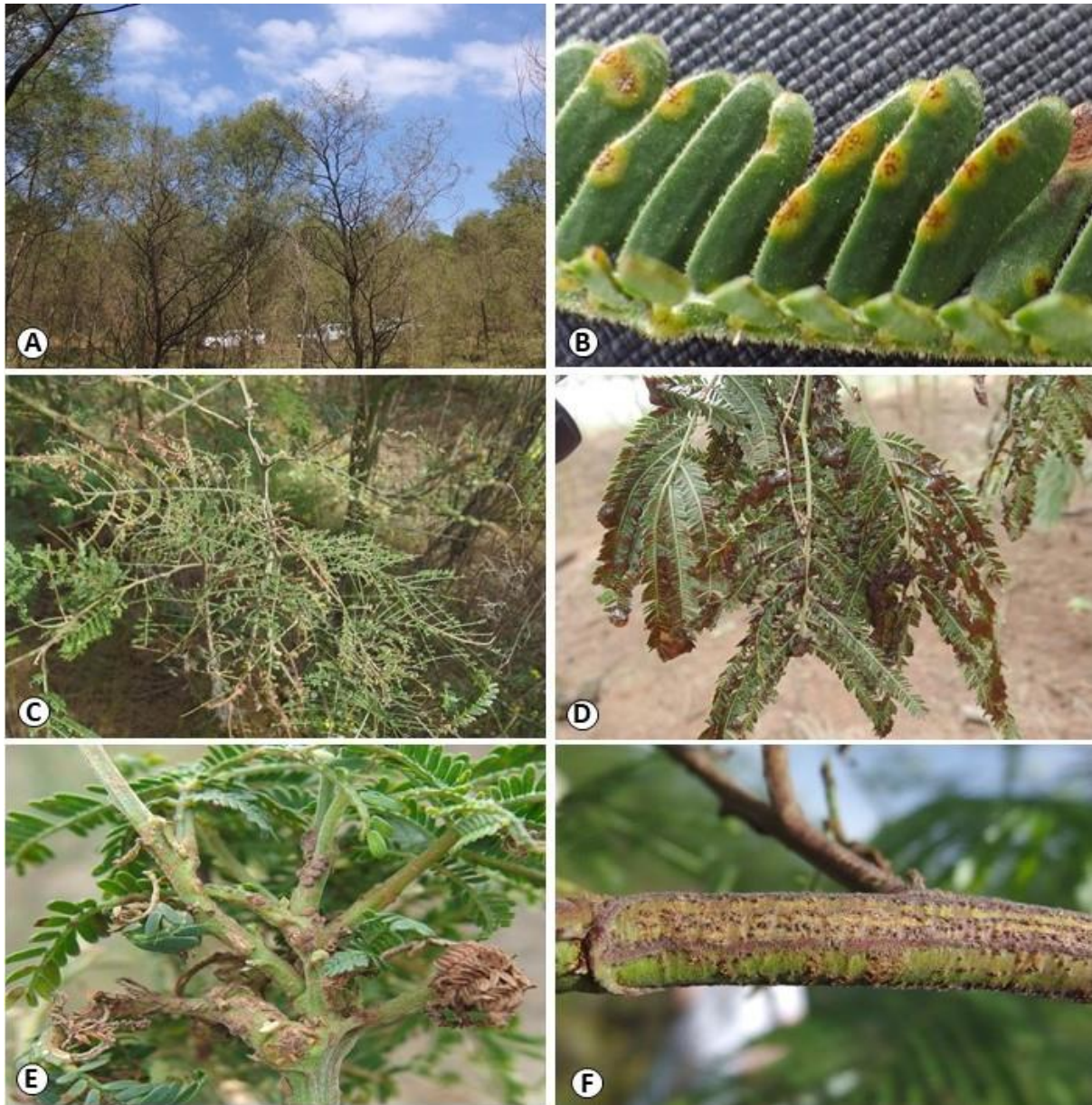

Figure 2. *Uromycladium acaciae*, wattle rust, on *Acacia mearnsii*. (A) Defoliation and malformation of heavily affected trees, (B) small yellow spots on pinnules, often with the presence of fungal spores in the spots, (C) infestation may develop into pinnule drop, (D) under moist conditions slimy masses of brown spores (telia) accumulate on leaves and branches, (E) when dry, powdery brown masses of spores can be found on lesions on the leaves, petioles and stems, (F) lesions, with or without spores may also be found on the green stems of younger trees.

sappi

2.1.3 Elsinoë shoot and leaf disease

A new shoot and leaf disease of eucalypts has been discovered in South Africa. The pathogen is in the fungal genus *Elsinoë* and has been shown to represent an undescribed species. The disease is currently only known from Indonesia, and now South Africa.

Causal agent: *Elsinoë necatrix*

Hosts and distribution: The disease has to date been found on *Eucalyptus grandis* x *E. nitens* (GN) and *E. grandis* x *E. urophylla* (GU) in both KwaZulu-Natal and parts of Mpumalanga.

Biology: Information from Indonesia suggests that the pathogen is highly dependent on high humidity and moisture accumulation on leaves and shoots for spore germination and infection.

Symptoms:

- Small, necrotic spots (about 1 mm in diameter) that first appear on young leaves, petioles and shoots (Figures 1A, B, C). These spots may be surrounded by a yellowish or reddish halo (Figure 1C).
- Spots become black at their centres as they age and later become raised and scab-like (Figure 1D, F).
- Scabs of older lesions on leaves may drop off leaving small holes in the leaves (Figures 1E, F).
- More susceptible trees may develop small, deformed leaves, elongated shoots, or leaves and shoots may die, resulting in a sparse/thin canopy often described as being “feathered” (Figure 1G).

Management: No disease management strategies are currently available as the disease is new to science and South Africa is only the second country where it has been found. Notify the Sappi Pests and Diseases Programme if you suspect this disease in your plantations.

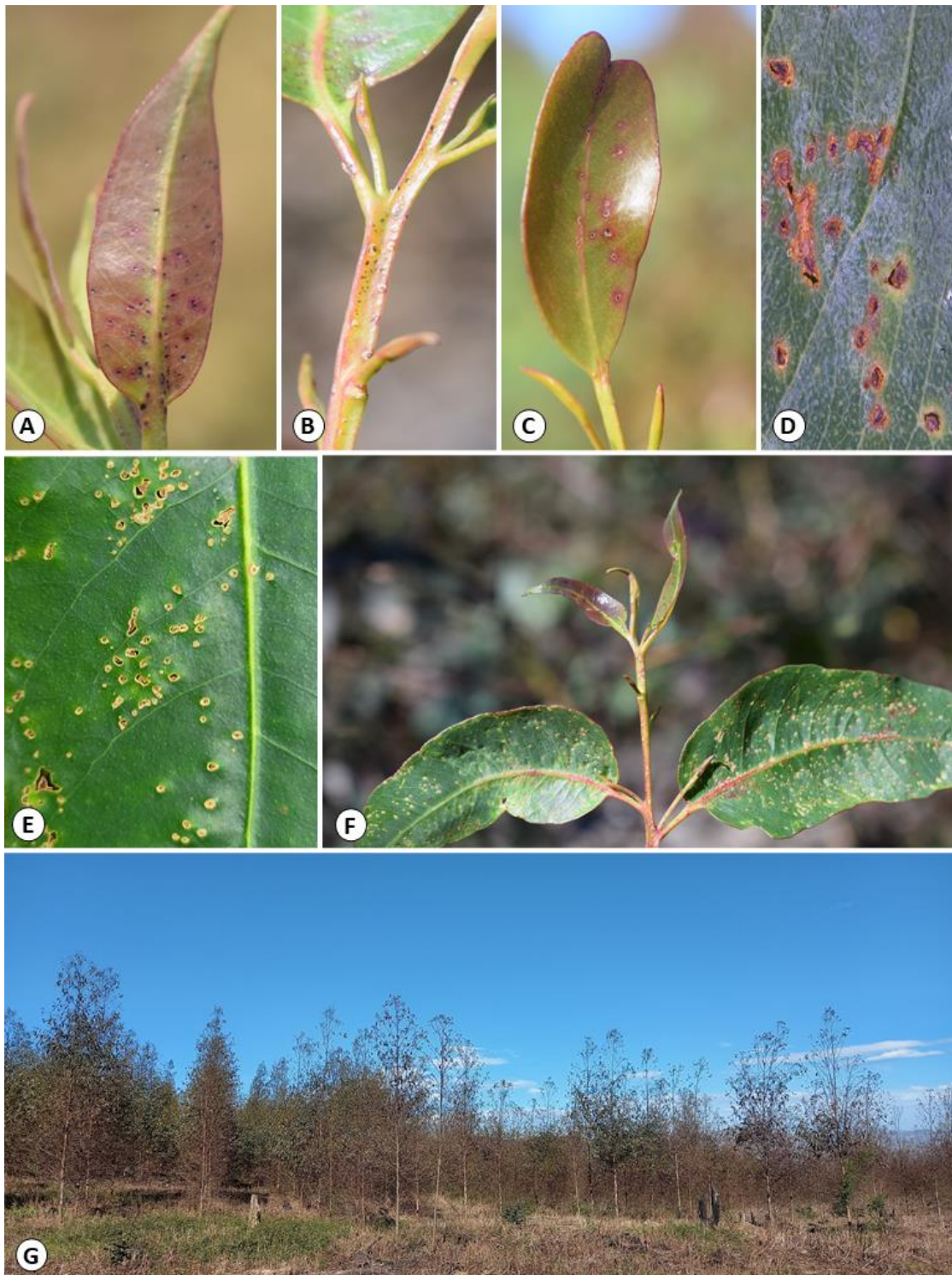

Figure 1. Elsinoë scab and shoot malformation disease of *Eucalyptus*. (A) Small necrotic spots developing on young leaf; (B) necrotic, black spots on young shoot; (C) developing spots on young leaf; (D) rough, scab-like spots of older infections; (E) scab like spots resulting in dead leaf material falling from leaf leaving holes in the leaf; (F) infected branch tip with young, developing black spots on youngest leaves and shoot tip and older, scab-like spots on older leaf and shoot; (G) thin, sparse canopies of heavily affected *Eucalyptus* genotype, resulting in a “feathered” appearance of the canopies.

2.2 Stem/branch diseases

2.2.1 Botryosphaeria canker

This disease occurs on both *Acacia mearnsii* (black wattle) and Eucalypts. A similar disease, Diplodia canker, occurs on Pines.

Causal agents: Previously known as *Botryosphaeria* species, it is now known that the causal agents comprise several genera, including *Neofusicoccum*, *Lasiodiplodia* and *Diplodia*, all classified in the family Botryosphaeriaceae.

Hosts: *Acacia mearnsii*, Eucalypts (Diplodia on pine covered later in chapter)

Damage: Tip, branch and/or tree death. Stem cracking and kino/gum pockets in wood. Double leaders as a result of tip-death. Reduces wood quality (visual blemishes in wood); causes structural weakness as result of kino/gum pockets. May impact on debarking in severe cases.

Biology: These fungi are opportunistic pathogens that manifest under conditions of environmental stress. These stress symptoms include drought, frosts, cold and hot winds, branch pruning, insect damage and off-site planting. The fungi spread via airborne spores that can also be spread through rain splash. May infect trees through stomata on the leaves. Fungi in the Botryosphaeriaceae can infect trees without causing visible signs of disease. Only after the onset of stress does infection become apparent when the fungus starts causing disease symptoms.

Symptoms: There are many symptoms associated with the disease. A common symptom is death of branch/tree tips/tops (Figure 3A), kino/gum exudation from cracks and cankers in the bark and wood. These exudations result in trees having a red or black appearance (Figure 3B). Stem cankers first become visible as small cracks, with the exudation of kino/gum. These cracks may develop into larger, girdling cankers, which affect wood quality and growth badly, and may result in stem breakages. Cutting into the stems/branches of affected trees reveals the presence of kino/gum rings (Figure 3C) and discoloured wood (Figure 3D).

Management: Site species/genotype matching is critical in avoiding/minimizing stress to trees. This in turn will reduce chances of Botryosphaeria canker and die-back affecting trees. Selecting and breeding of disease and stress tolerant genotypes.

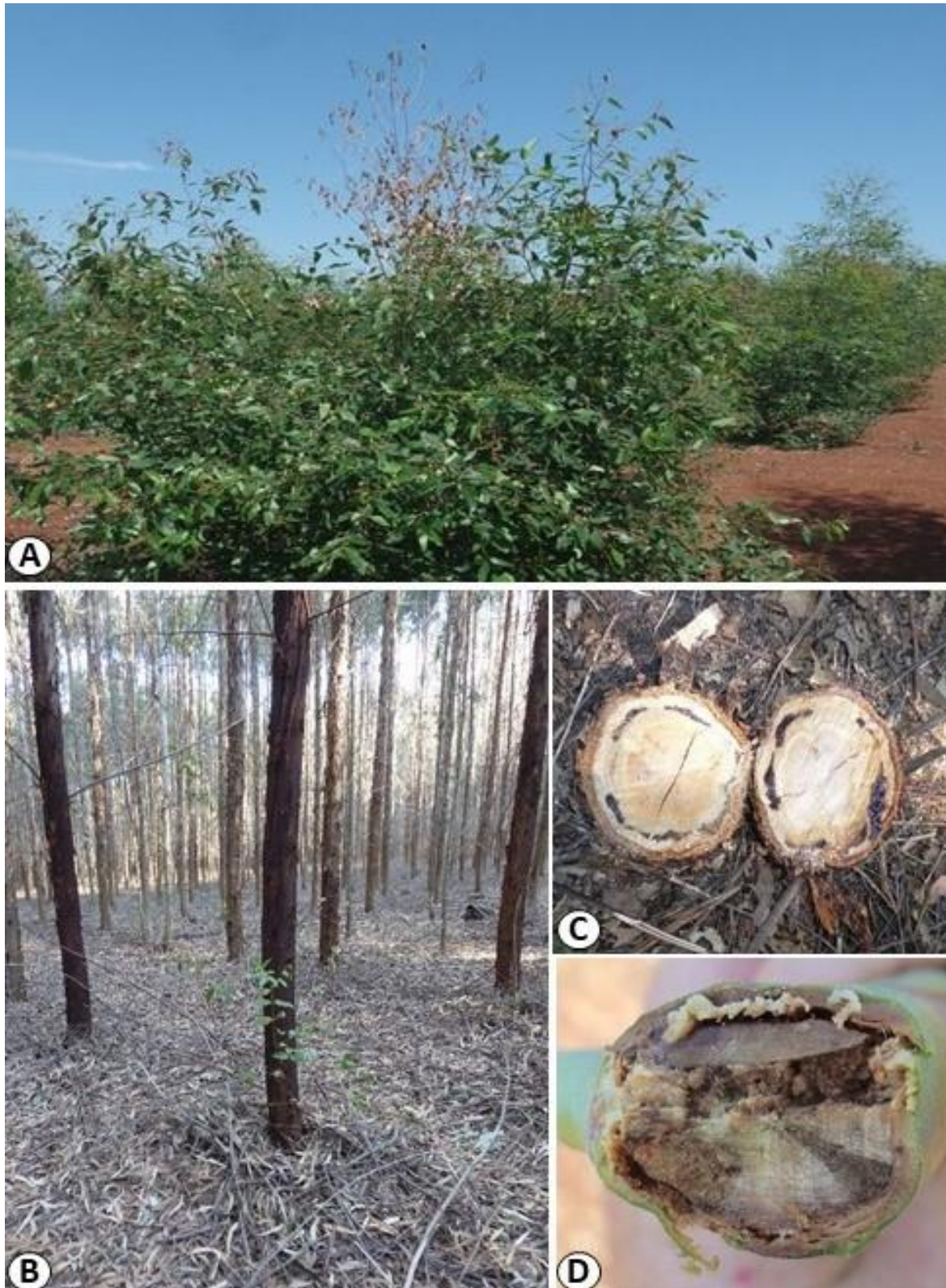

Figure 3. Symptoms of *Botryosphaeria* stem canker on eucalypts. (A) death of tree tips/tops, (B) kino from cracks and cankers in the bark and wood resulting in trees having a red or black appearance, (C) cutting into the stems/branches of affected trees reveals the presence of kino rings and (D) and discoloured wood.

sappi

2.2.2 Coniothyrium stem canker

Causal agents: *Teratosphaeria zuluensis*. A second species, *T. gauchensis*, is common in Zimbabwe. The pathogen was previously known as *Coniothyrium zuluense*.

Hosts: Various eucalypt species and hybrids of *Eucalyptus grandis*. Not a problem on cold tolerant/temperate eucalypt species such as *E. dunnii*, *E. smithii* or GN hybrids.

Damage: Spots and cracks on the stems and branches of trees. Does not kill the tree but renders the wood brittle and unsuitable for construction and saw timber use. Reduces wood quality (visual blemishes in wood); causes structural weakness as result of the kino pockets. Severe infection may impact on debarking.

Severe infection may result in spindle-shaped swellings on the stems of trees. Epicormic shoots are produced on the stems and the tops of trees begin to die. Lateral branches will attain apical dominance, but these will in turn also become infected resulting in cessation of height growth.

Biology: Small, single celled spores are spread by wind and water. The spores infect the stems directly through the epidermis of the young stem tissue. Coniothyrium stem canker mostly affects trees from approximately 2 years and older, but in the Zululand region has been seen on trees as young as 12 months old.

Symptoms: Circular spots (Figure 4A, B, C) on the stems and branches of trees. Initial infections occur on the young, green stem tissue and give rise to small discrete spots on the bark (Figure 4C) or girdling lesions on the branches (Figure 4G). These lesions may merge to give rise to large patches of dead, cracked, black bark, which exudes copious amounts of kino. Coniothyrium canker in South Africa is often referred to as "measles disease". Internally, in the wood of trees the disease can be recognized by distinct black kino pockets (Figure 4B, D, E, F).

Management: Selection and breeding to select tolerant/resistant genotypes.

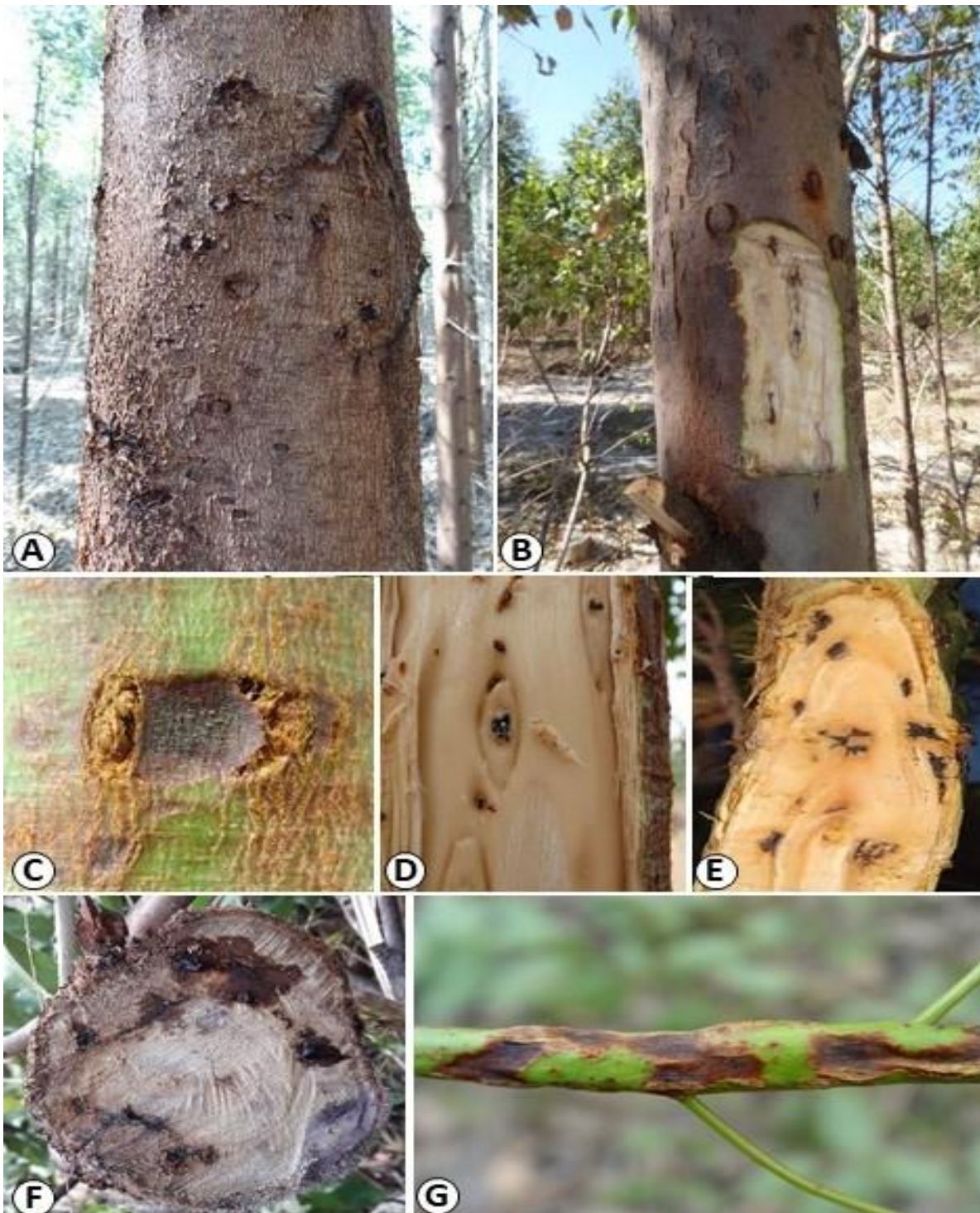

Figure 4. Coniothyrium stem canker (*Teratosphaeria zuluensis*) symptoms. (A, C) Circular spots in the bark of stems and branches, with small black fruiting bodies (C) visible in the spots, (B, D, E, F) internally, in the wood of affected trees the disease can be recognized by distinct black kino pockets, (G) on green branches girdling lesions may develop leading to branch death.

sappi

2.2.3 Diplodia canker/die-back/blue stain

Causal agent: *Diplodia sapinea* (previously known as *Sphaeropsis sapinea* and *Diplodia pinea*). This pathogen is related to the Botryosphaeriaceae that affect eucalypts and wattles.

Hosts: Diplodia canker and die-back affects all *Pinus* species but is especially common and most severe on *Pinus patula*, *P. pinaster* and *P. radiata*. A root disease of *P. elliotii* and *P. taeda*, caused by *D. sapinea* has also been found.

Damage: Shoot blight and die-back, stem cankers, root diseases and blue stain. Many of these symptoms become apparent after hail damage or when trees are stressed due to factors such as drought or fire damage. The root disease is associated with stress from overstocking, drought, or planting on poor sites. Trees may die from Diplodia canker. Blue stain impacts on timber quality (not strength).

Biology: *Diplodia sapinea* exists as both an endophyte and saprophyte in/on healthy and dead tissue. This fungus is an opportunistic pathogen causing disease symptoms when wounds or other stress factors occur. It is especially problematic after hail damage to trees. It may also infect young, unwounded pine shoots, where moisture and warm conditions occur at the onset of growth. The fungus is spread via airborne spores.

Symptoms: The symptoms may include shoot blight or die-back (Figure 5A, B), stem cankers (Figure 5C), root diseases and blue stain (Figure 5D). Characteristic symptoms of the root disease are dark-blue, radial lesions in young roots, which extend to larger roots and into the trunk of diseased trees.

Management: Avoid planting of susceptible species, such as *P. patula*, in hail belts. Site species matching to reduce stress on trees. Restrict pruning of susceptible species to colder, drier times of the year when the fungus is less active, and conditions are less favourable for spore germination.

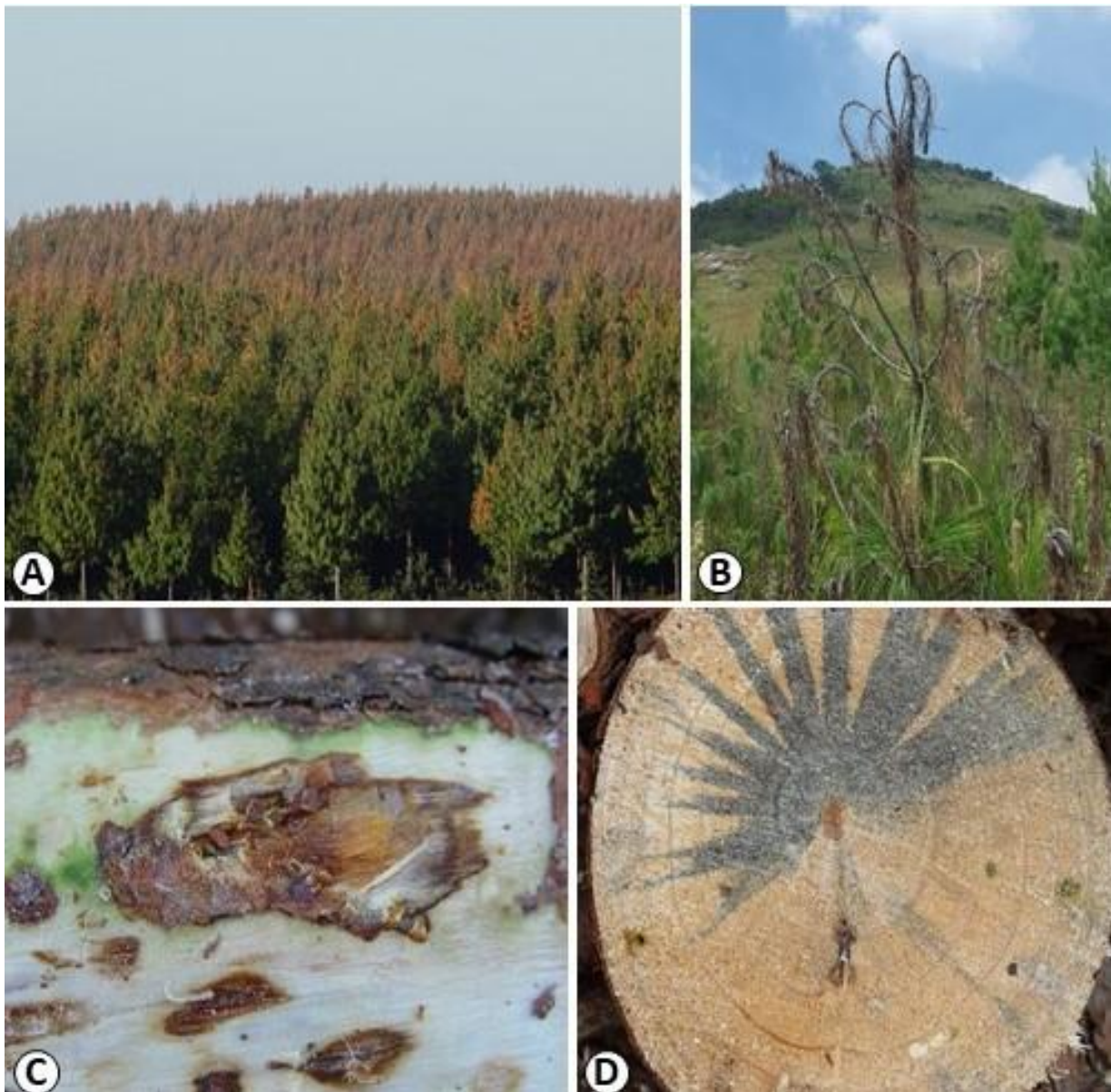

Figure 5. *Sphaeropsis sapinea* symptoms on Pines. (A, B) Shoot blight or die-back after hail damage, (C), stem lesions after hail damage, (D) blue stain associated with *Sirex noctilio* infestation.

2.2.4 Pitch canker

This disease, the plantation manifestation of the pitch canker fungus (*Fusarium circinatum*), is not yet common in the eastern and northern parts of South Africa. Isolated incidences have been confirmed on *P. patula* in Limpopo, on *P. greggii* in the KwaZulu-Natal Midlands and North-eastern Cape. On *P. radiata* in the Southern Cape the disease is more common. *Fusarium circinatum* is a major problem in nurseries, causing a root and collar disease of seedlings. The nursery disease may be transmitted into the field at establishment and beyond, killing young trees up to the age of four or five as a result of asymptomatic root infections in the nursery. This is visible in the field as resin-soaked root collar cankers.

Causal agent: *Fusarium circinatum*

Hosts: *Pinus* species, especially *P. patula*, *P. radiata*, *P. greggii*. Species such as *P. elliottii* and *P. taeda* are more resistant, so too hybrids of *P. patula* with *P. techunumanii* (PPTL) and *P. oocarpa* (POCH).

Damage: Branch and tip death, resinous stem and branch cankers and pitch/resin-soaked wood. Entire trees may die.

Biology: *Fusarium circinatum* is capable of infecting both vegetative and reproductive structures of pines at any stage of their maturity. Spores of the fungus are soil and air borne. In nurseries it can also be found in water. Insects such as *Pissodes* spp. have been associated with the disease. *Fusarium circinatum* is an opportunistic pathogen and relies on wounds for infection. These wounds could be as a result of insect damage, routine management practices or weather-related injuries. The pathogen can survive in dead branches and wood chips for up to three years, depending on environmental conditions. It has also been isolated from grasses in pine plantations.

Symptoms: From a distance dead branches (flagging) in the canopy of trees may be visible (Figure 6A, B, E). Closer inspection will reveal extensive resin exudation/bleeding from cankers on the stems or root collars of trees (Figure 6C, F). Cutting into the cankers will show pitch/resin-soaked wood (Figure 6D, F).

Management: Selection and breeding for disease tolerant/resistant genotypes. Avoid wounding, e.g., pruning of trees under warm, moist conditions (summer).

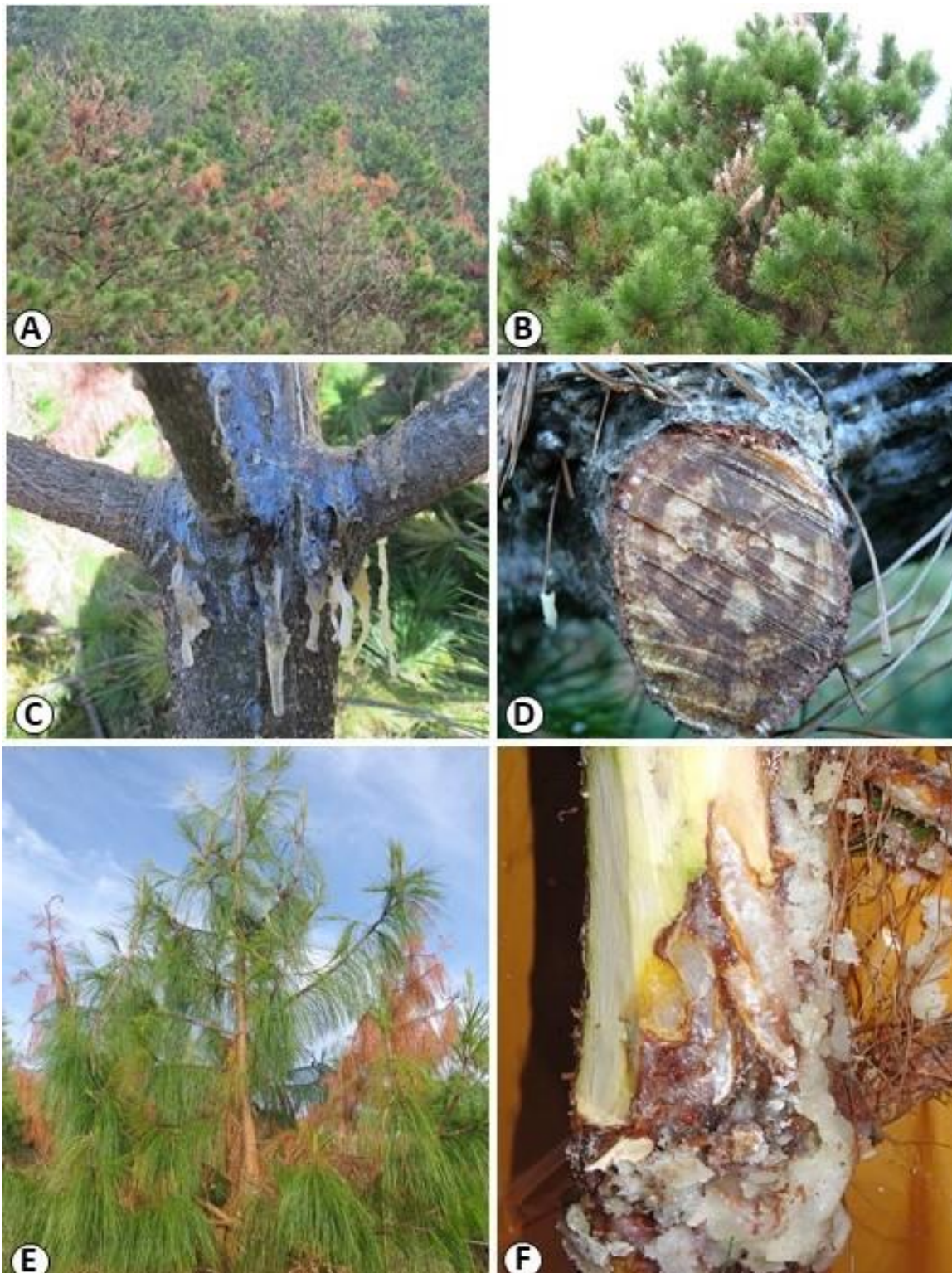

Figure 6. Symptoms of pine pitch canker disease caused by *Fusarium circinatum*. (A, B, E) Dead branches (flagging) in the canopy of trees, (C, F) closer inspection will reveal extensive resin exudation/bleeding from cankers on the stems or root collars of trees, (D) cutting into the cankers will show pitch/resin-soaked wood.

2.3 Wilt and root diseases

2.3.1 Bacterial wilt

Causal agents: Bacteria in the genus *Ralstonia*. In forestry in South Africa; *R. pseudosolanacearum*.

Hosts: Eucalypts, especially in warmer areas in Zululand and Mpumalanga Lowveld.

Damage: Infection by *R. pseudosolanacearum* results in the rot of roots and death of infected trees. Especially young trees less than one year old are susceptible, but mortality has been reported on trees of up to two years in age. Trees that are not killed by the disease may continue growing but will have less vigour.

Biology: *R. pseudosolanacearum* is a soil borne, motile bacterium. Infection occurs through wounds in the roots and root collar area of trees. It has a wide host range and may survive in the soil on plant roots and debris for extended periods of time. *R. pseudosolanacearum* may be spread by infected soil and plant material. Localised spread within a compartment is facilitated by water movement (water logging) and the movement of animals, humans, and silvicultural equipment. The disease is especially common after periods of high rainfall and has been commonly associated with tree stress as a result of bad root formation (ball and socket, root strangling, J-rooting).

Symptoms: Leaf chlorosis, wilt (Figure 7A, B) and death of trees. The first symptoms usually become visible with the death of single branches in the lower canopy of trees. The roots of trees are rotten and bark in the region of the root collars may be cracked. The xylem of affected trees shows discolouration in the form of brown to black “streaks” (Figure 7C, D). A creamy to white “bacterial ooze” often appears on the cut surfaces of infected trees (Figure 7D, E). This bacterial ooze can also be seen by placing the cut end of a branch, root, or stem into a glass of clear water and waiting for a few minutes (Figure 7F). Trees affected by this disease are often found in patches within a stand.

Management: No known management for the disease. Because of its association with bad root systems care should be taken to plant only trees with a good PQI (Plant Quality Index) and be vigilant to apply good planting practices.

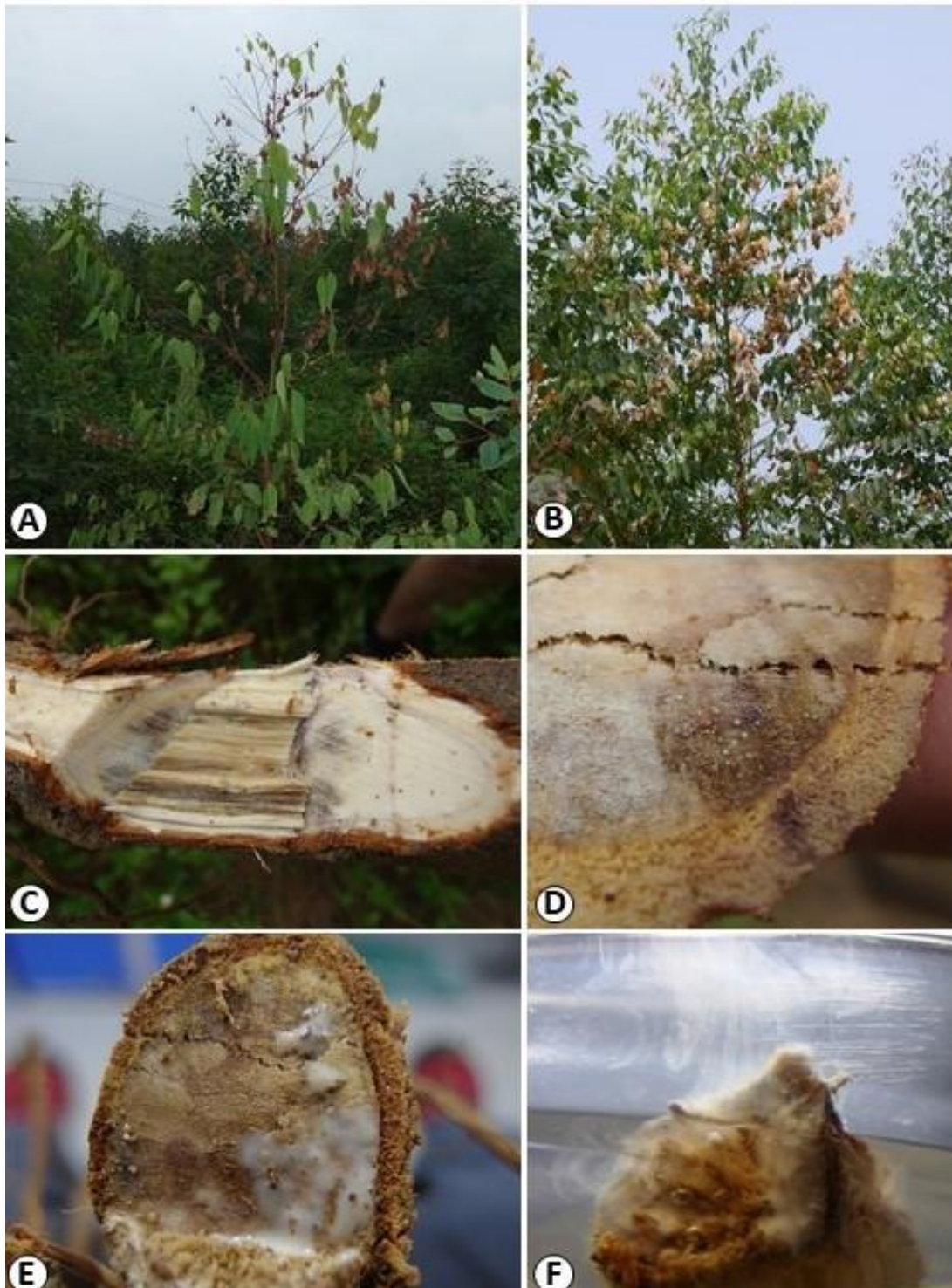

Figure 7. Bacterial wilt symptoms and signs. (A, B) Leaf chlorosis, branch death, (C) xylem discolouration in the form of brown to black “streaks”, (D, E) cream to white “bacterial ooze” on the cut surfaces of infected trees, (F) bacterial ooze can also be seen by placing the cut end of a branch, root or stem into a glass of clear water and waiting for a few minutes.

2.3.2 Ceratocystis wilt

Ceratocystis wilt of wattle was first described in 1989 from the KwaZulu-Natal Midlands, while the disease on eucalypts was first noticed in 2019 in the Zululand region. Ceratocystis wilt of eucalypts is one of the two most serious diseases of eucalypts in Brazil, while wattle wilt caused by *C. albifundus*, is one of the most important diseases of these trees in South Africa.

Causal agents: *Acacia mearnsii* – *Ceratocystis albifundus*, a native African fungus.
Eucalypts – *Ceratocystis eucalypticola*, a suspected introduced (non-native) fungus of unknown origin.

Hosts: *Ceratocystis albifundus* mainly causes disease of black wattle but has also been observed affecting green wattle. It has a wide host range on native South African trees but does not cause disease/death of its native hosts, except where these are cultivated (e.g., Protea farms in Western Cape). *Ceratocystis eucalypticola* in South Africa is known only from eucalypts.

Damage: Tree death. In the case of eucalypts where trees are not killed, they are smaller than uninfected trees. Pilot studies show that infection of eucalypt roots/root collar negatively impact on coppicing ability of susceptible genotypes.

Biology: *Ceratocystis* species require wounds through which to infect their hosts. Pruning or thinning wounds on wattle are commonly infected, so too hail wounds. *Ceratocystis* species are commonly associated with insects, especially nitidulid (picnic) beetles in South Africa. *Ceratocystis albifundus* and others have, however, also been isolated from mites and other plant inhabiting insects, assisting in the spreading of spores of the fungus. *Ceratocystis eucalypticola* has been isolated from soil in eucalypt compartments and is commonly associated with root infections on these trees.

Symptoms: Both *C. albifundus* and *C. eucalypticola* may result in rapid wilt and death of susceptible trees. This may be preceded by leaf/foilage discolouration, reddening/yellowing of foliage on trees (Figure 8A, B). Lesions may or may not be present in the bark, and there may be basal malformation on eucalypts (Figure 8C). Cutting into the bark will reveal speckling/spotting in the bark (Figure 8D). When cutting into the wood, brown to blue/black streaks may be visible and in cross segments this will be visible as a roseate pattern (Figure 8E).

Management: Selection and breeding of disease tolerant/resistant genotypes. *Ceratocystis* species require wounds for infection. Severe disease outbreaks have especially been found after hail and silvicultural (pruning, thinning) damage. Prevention of wounds during summer will reduce chances of disease.

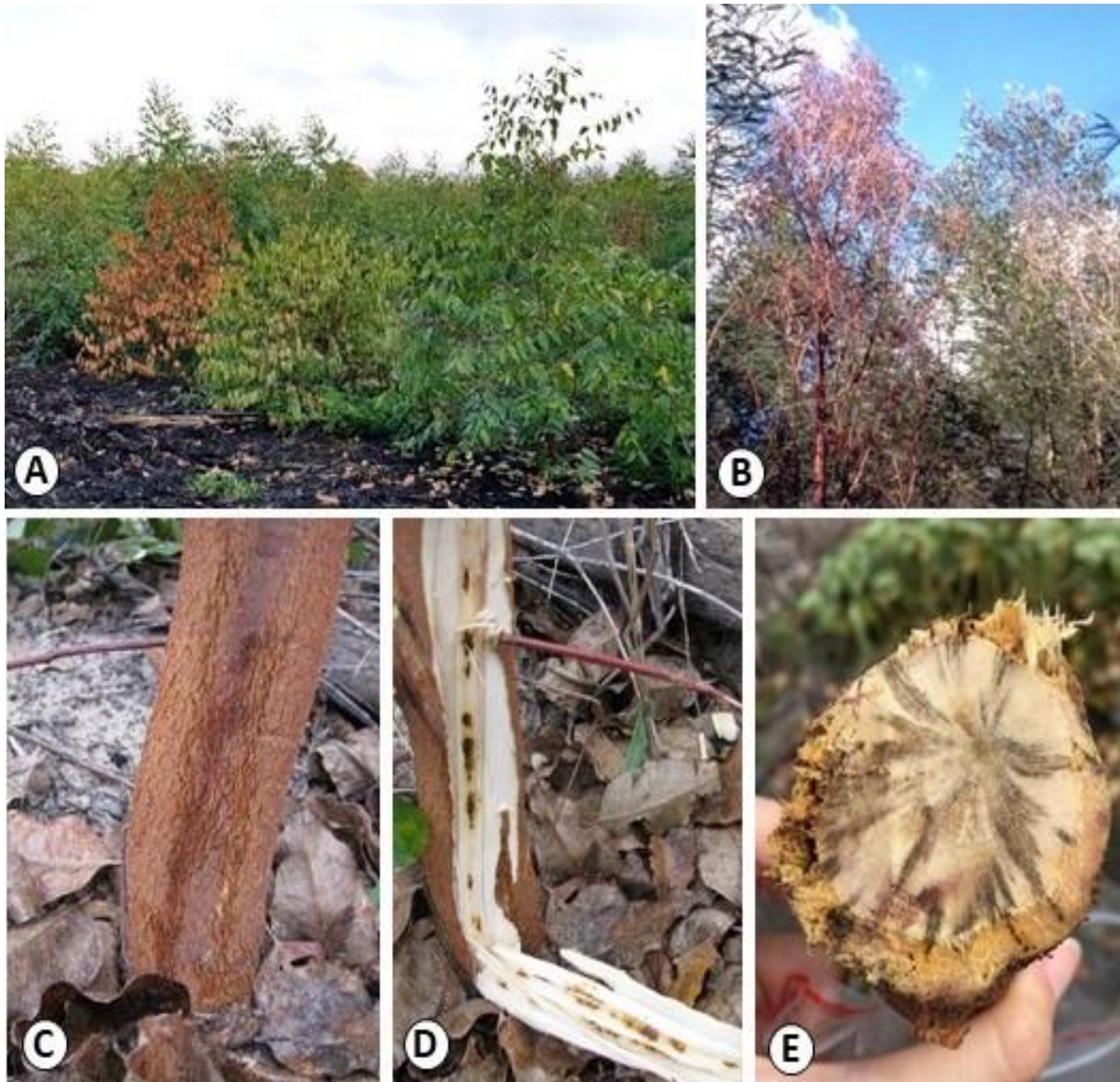

Figure 8. Ceratocystis wilt symptoms on eucalypts and black wattle. (A, B) leaf/foilage discolouration, reddening/yellowing and complete tree death, (C) basal malformation on eucalypts, (D) cutting into the bark will reveal speckling/spotting in the bark, (E) when cutting into the wood brown to blue/black streaks may be visible and in cross segments this will be visible as a roseate pattern.

2.3.3 Phytophthora root rot

Causal agents: Several species of *Phytophthora* cause disease of eucalypts and *Acacia mearnsii* in South Africa. These include *P. cinnamomi*, *P. alticola* and *P. frigida* on eucalypts and *P. nocotianae* on wattle.

Hosts: Mainly the cold tolerant eucalypts. i.e., *Eucalyptus smithii*, *E. nitens*, *E. fraxinoides* and *E. fastigata*. The disease has also been found on *E. grandis* and *E. benthamii*.

A common disease on *Acacia mearnsii*, but the disease has also been found on *A. decurrens*.

Damage: *Phytophthora* species cause tree wilt and death as result of root and collar rot in susceptible trees. On wattle they also affect the quality of the bark at the bases of trees, reducing bark yield. Apart from causing tree death, the damage they do to the fine roots of trees result in reduced root systems and thus reduced vigour and growth. This also makes trees more susceptible to water stress (drought).

Biology: Most *Phytophthora* species require water/free moisture for spore production, spread and germination. Water logging and the resulting poor aeration of the soil predisposes tree roots to infection. *Phytophthora* spores are commonly spread via infected soil or water. *Phytophthora* spp. have motile spores (zoospores), which readily swim through the water to find fresh roots and root collars for infection. *Phytophthora* species do not necessarily result in outright tree death, but they kill fine roots, resulting in reduced root structures and tree vigour.

Symptoms: Young trees start dying a few months after planting. Dying trees usually occur in clusters or along planting lines. The most obvious symptom on infected trees is a general wilting of the leaves and whole tree death (Figure 9A), following the rotting of the cambium of the roots and root collar (Figure 9B). The bark from infected roots easily slips off the woody parts. Infections on older trees may be visible as bark cracks and bleeding from the basal sections (Figure 9C, D). On wattle, the bark at the bases of trees is often completely black. *Phytophthora* root and collar rot may also lead to secondary causes of mortality such as wind-throw due to reduced root systems.

Management: Selection and breeding of disease tolerant/resistant species. Avoid planting susceptible species on sites that favour the disease. Avoid planting in waterlogged or poorly drained soils. Avoid damage to the roots and bases of the seedlings when planting and during subsequent maintenance activities.

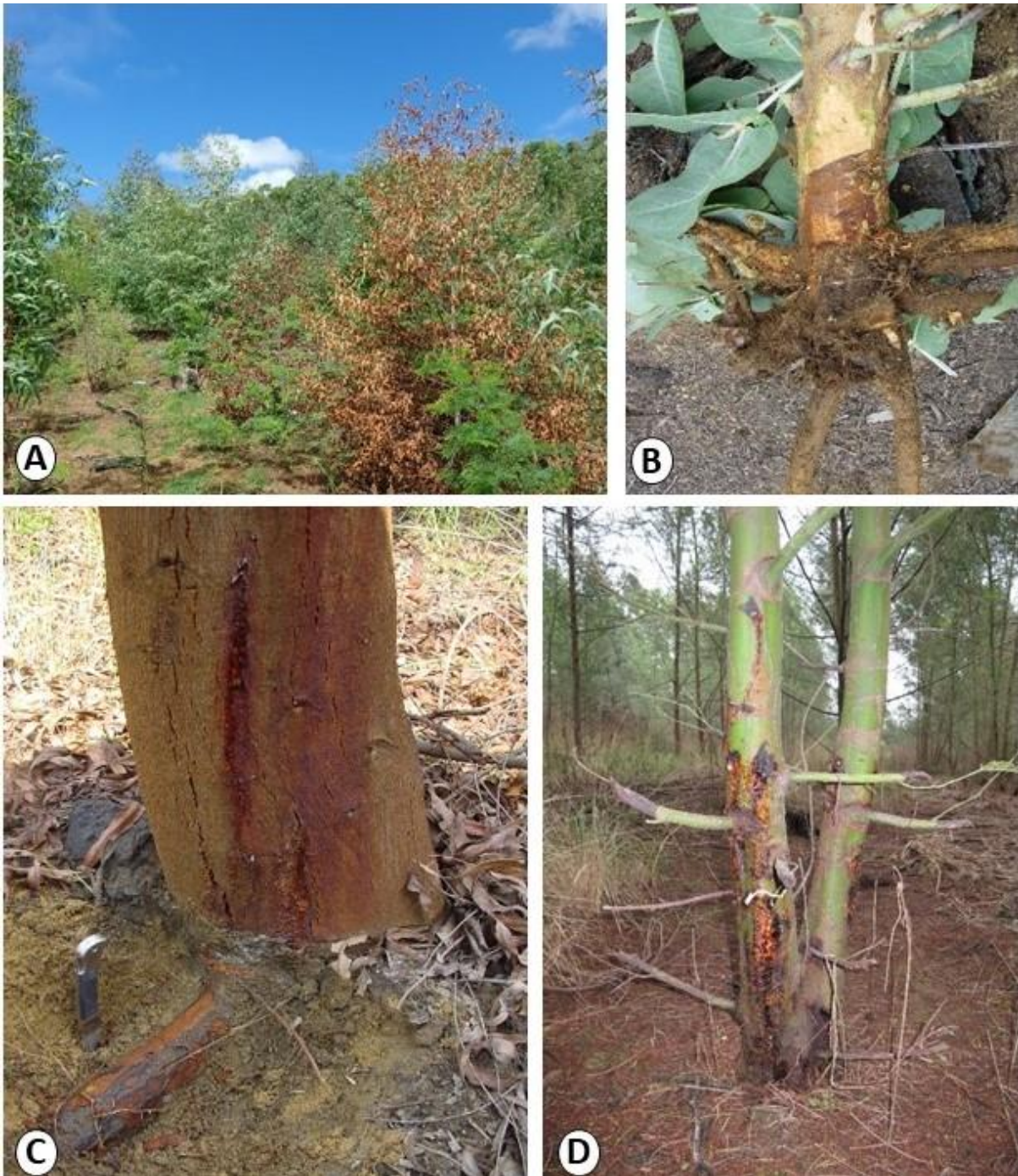

Figure 9. Phytophthora root and collar rot on eucalypts and wattle. (A) Discolouration and wilting of leaves and whole tree death, (B), root and cambium death at root collar, (C, D) infections on older trees may be visible as bark cracks and bleeding from the basal sections. On wattle, the bark at the bases of trees is often completely black.

2.3.4 Rhizina root rot

Causal agent: *Rhizina undulata*

Hosts: *Pinus* species

Damage: Kills young plants shortly after transplanting. May kill older trees also. May result in vigour loss in older trees.

Biology: *Rhizina undulata* is a soil borne pathogen associated with fire. It can survive in infected tree roots for several years. It requires high temperatures (50°C and higher), e.g., caused by fire, for spore germination. It is only a problem in areas where pine has been planted before. Hot fires before plantation re-establishment should be avoided, or planting delayed for several months to avoid losses.

Symptoms: Wilting and death of young plants (Figure 10A) as a result of root rot. Fungal fruiting bodies may be present in the compartment for a few weeks/months after fire. These start as shiny red, flattish structures (Figure 10B), often with white margins. They can range in size from that of a 5c/small coin to the size of a small plate. As the fruiting bodies age, they become darker (Figure 10C, D) and eventually black with age. They may resemble cow dung when old. Fine yellow fungal mycelium may be observed on the surfaces of infected roots. On older trees resin exudation may be visible from the bases of stems.

Management: Avoid hot fires to clear plantations after harvesting. Application of fungicide as a soil drench at planting has been shown to reduce incidence of *Rhizina* death (ICFR Reports), but none are currently registered for this use in plantation forestry. Alternatively, plant areas that had hot fires to eucalypt or wattle, or let area lie fallow over winter to allow *Rhizina* spores to go dormant before planting.



Figure 10. Rhizina root rot and fruiting bodies. (A) Wilting and death of young plants, (B) young, shiny red, developing fruiting bodies with white margins, (C, D) darker, mature fruiting bodies with a rubbery texture.

3. PESTS OF EUCALYPTS, PINES AND WATTLE

3.1 Foliar pests

3.1.1 *Gonipterus* snout beetle

Insect: *Gonipterus* sp. 2

Hosts: Various *Eucalyptus* species and hybrids, especially *E. dunnii*, but *E. smithii*, GN and GU also affected.

Damage: Defoliation, growth tip defoliation, bark feeding and girdling, stunting, heavy branching, and tree mortality. *Gonipterus* sp. 2 may attack trees as young as six months old, up to mature trees. Multiple years of defoliation, especially in late summer, may result in significant growth loss (>20%).

Biology: Beetles usually live two to three months but may survive for up to seven months. Adults can live for several weeks without food and water. In winter they may go into diapause (a period of suspended development/dormancy). Females produce up to 30 egg capsules (270 eggs), which are oviposited on young developing leaves that appear just behind the growth tips of eucalypt shoots. Adults will not oviposit on older more mature foliage and can cease oviposition when conditions are unsuitable (i.e., no young foliage). The larvae are noticeable on the leaves for 28 to 40 days, after which they drop off and pupate in the soil.

Symptoms/signs: Presence of adults clinging to branches and leaves (Figure 11A), yellow larvae feeding on leaves (Figure 11B), egg capsules on young foliage (Figure 11C), leaf mining tracks caused by feeding larvae (Figure 11D), serrated leaf edges caused by feeding adults (Figure 11E) and die-back/defoliation of tree canopies (Figure 11F).

Management: A biological control agent, *Anaphes nitens*, was introduced to South Africa nearly 100 years ago to reduce population levels of *Gonipterus*. In recent decades increased outbreaks of *Gonipterus* sp. 2 has, however, been experienced. This may be due to, among others, the planting of more susceptible eucalypts, e.g., *E. dunnii*, or failure of the biological control agent to adapt to changing environmental conditions. The TPCP (FABI, UP) has recently introduced additional strains of *A. nitens*, from a broader geographic range in Australia, in attempts to improve the impact of *A. nitens* on *Gonipterus* sp. 2. Additional biological control agents, e.g., a larval parasitoid, are also being explored. Chemical control has proven successful to reduce *Gonipterus* sp. 2 population levels and damage and may be considered when the larval stage of the pest is in abundance (this stage is the most affected by chemical control).

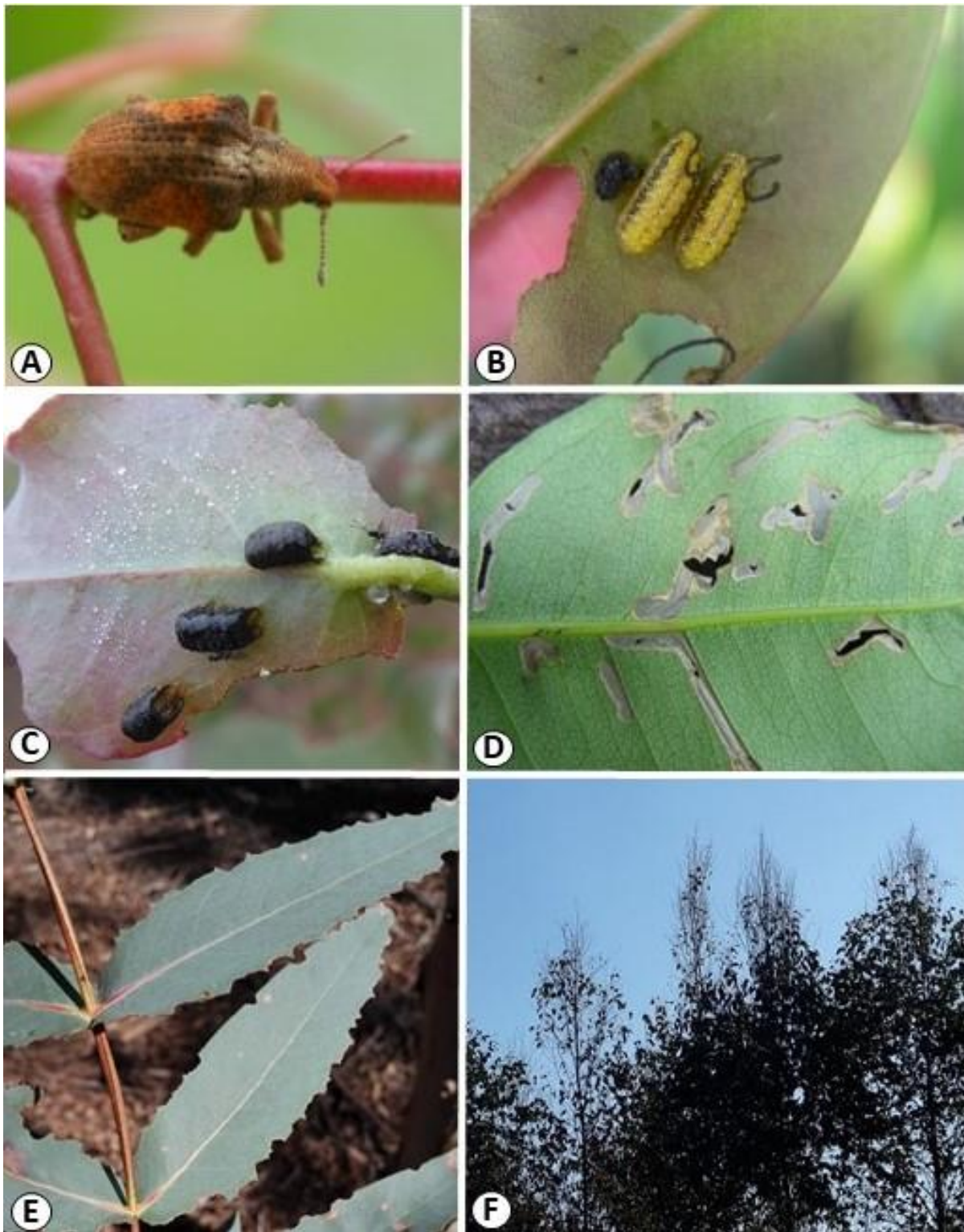

Figure 11. *Gonipterus* sp. 2 and typical damage it causes to eucalypts. (A) adult beetle, (B) yellow larvae with typical string of faeces exuding from hind section, (C) egg capsules on young foliage, (D) leaf mining tracks caused by feeding larvae, (E) serrated leaf edges caused by feeding adults, (F) die-back/defoliation of tree canopies.

sappi

3.1.2 Leptocybe gall wasp (Blue gum chalcid)

Insect: *Leptocybe invasa*. Two lineages of the wasp, called *Leptocybe A* and *Leptocybe B* are present in South Africa. Both now occur in all provinces.

Hosts: *Eucalyptus*, particularly *E. grandis* and GC varieties. Some GN varieties highly susceptible. GU resistant to varying degrees. *E. dunnii* tolerant in most cases. Some reports of heavy damage to *E. dunnii* have been received, but these are limited.

Damage: Formation of galls on midribs, petioles and stems results in stunted growth, injury to new foliage, defoliation, and tree mortality. Young trees may be totally malformed, with no normal leaf growth when heavily affected.

Biology: Females oviposit their eggs on young, fresh foliage, and introduce a chemical which stimulates cell growth, resulting in the formation of galls on the mid-ribs, petioles, and stems of new growth of young trees or coppice, as well as nursery seedlings/cuttings. Wasps are most active during summer months and oviposition occurs mostly during this time. Annually there are 3-4 overlapping generations. Leaves that carry mature galls in the autumn are shed during the winter. Wasps that inhabit galls in the early winter start to emerge in spring. The activity of the wasp resumes only after the cold period, when the average maximum temperatures has risen above 20°C.

Symptoms/signs: Development of “little leaf” syndrome (Figure 12A) as a result of oviposition on developing young leaves, formation of galls on the petioles (Figure 12B), midrib (Figure 12C) and young branches (Figure 12D), presence of adult wasps (Figure 12E). Adults are very small, only a few millimetres in size.

Management: The biological control agent, *Selitrichoides neseri*, also a minute wasp, was introduced into South Africa to parasitize *Leptocybe* eggs. Two additional biological control agents, *Megastigmus zebrinus* and *Quadrastichus mendeli*, reached South Africa accidentally in recent years. Research has also shown the presence of other wasps in *Leptocybe* galls, e.g., *Megastigmus pretorianensis*.

Variation in susceptibility to *L. invasa* occurs and tolerant genotypes can be planted. Avoid planting susceptible genotypes in warmer areas, or early in summer when the gall wasp is most active. Some varieties may be heavily impacted when young, but grow out of the problem, however, the loss in growth has yet to be determined.

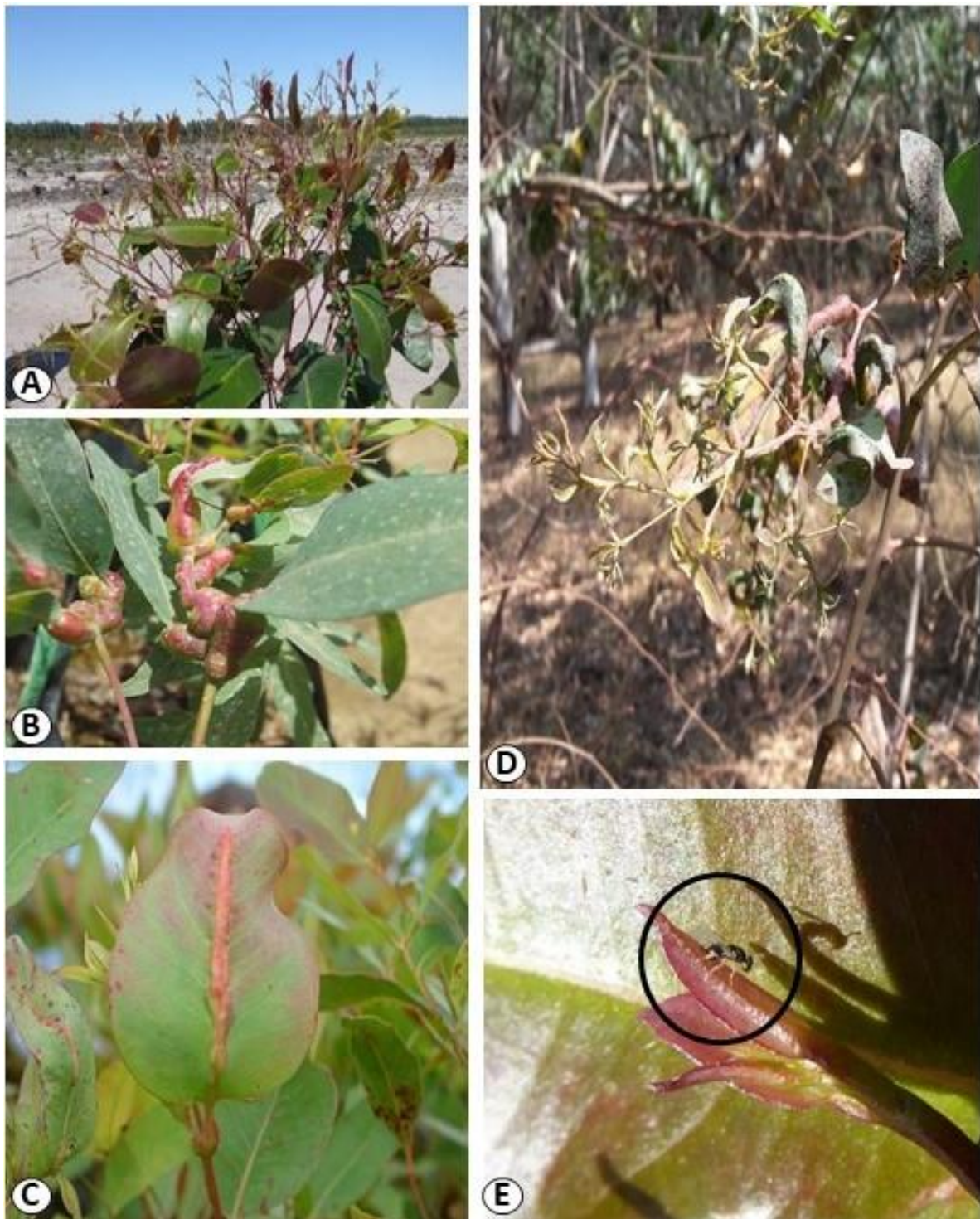

Figure 12. *Leptocybe invasa* gall wasp symptoms and signs on eucalypts. (A) “little leaf” syndrome as a result of oviposition on young developing shoots, (B) formation of galls on the petioles, (C) midrib galls, (D) leaf, petiole, and branch malformation due to galls, (E) adult wasp on new leaf.

sappi

3.1.3 Pine brown tail moth

Insect: *Euproctis terminalis*, a native South African moth.

Hosts: *Pinus* species

Damage: Larval feeding on needles leading to complete defoliation of trees; severe skin irritation and rash to forestry workers.

Biology: Moths, yellow in colour, fly during the day and lay eggs from October to February. Eggs are deposited on the trunks and on foliage, in elongated, irregularly shaped masses. The first caterpillar instars hang on silk threads which enables them to be dispersed in the canopy by the wind. Caterpillars are black to olive-brown, older ones have tufts of long, white hairs at the sides of each segment and a narrow centreline of white along the back. All the caterpillar stages are extremely hairy. These hairs cause intense irritation when in contact with the human skin and can cause allergic reactions in forestry workers.

Symptoms/signs: Green needles on the plantation floor as a result of larval feeding (Figure 13A), defoliation of crowns/bare crowns (Figure 13B), presence of hairy larvae on needles (Figure 13C), presence of pupae in needle mat and in soil of plantation floor (Figure 13D), yellow adult moths in compartments (Figure 13E), excrement pellets on the plantation floor (Figure 13F).

Management: Chemical pesticide applications are effective, but no chemicals on the current TIPWG (<https://www.tipwg.co.za>) or Sappi approved pesticide lists (APL) for this insect pest as none are registered for use in plantation forestry. The TPCP (FABI, UP) has identified a male attractant pheromone for possible trapping and/or mating disruption, but this still needs trial work and development for commercial use.

Natural enemies of the brown tail moth are present in compartments, but under certain conditions the moth population exceeds natural enemy populations, allowing pest outbreaks.

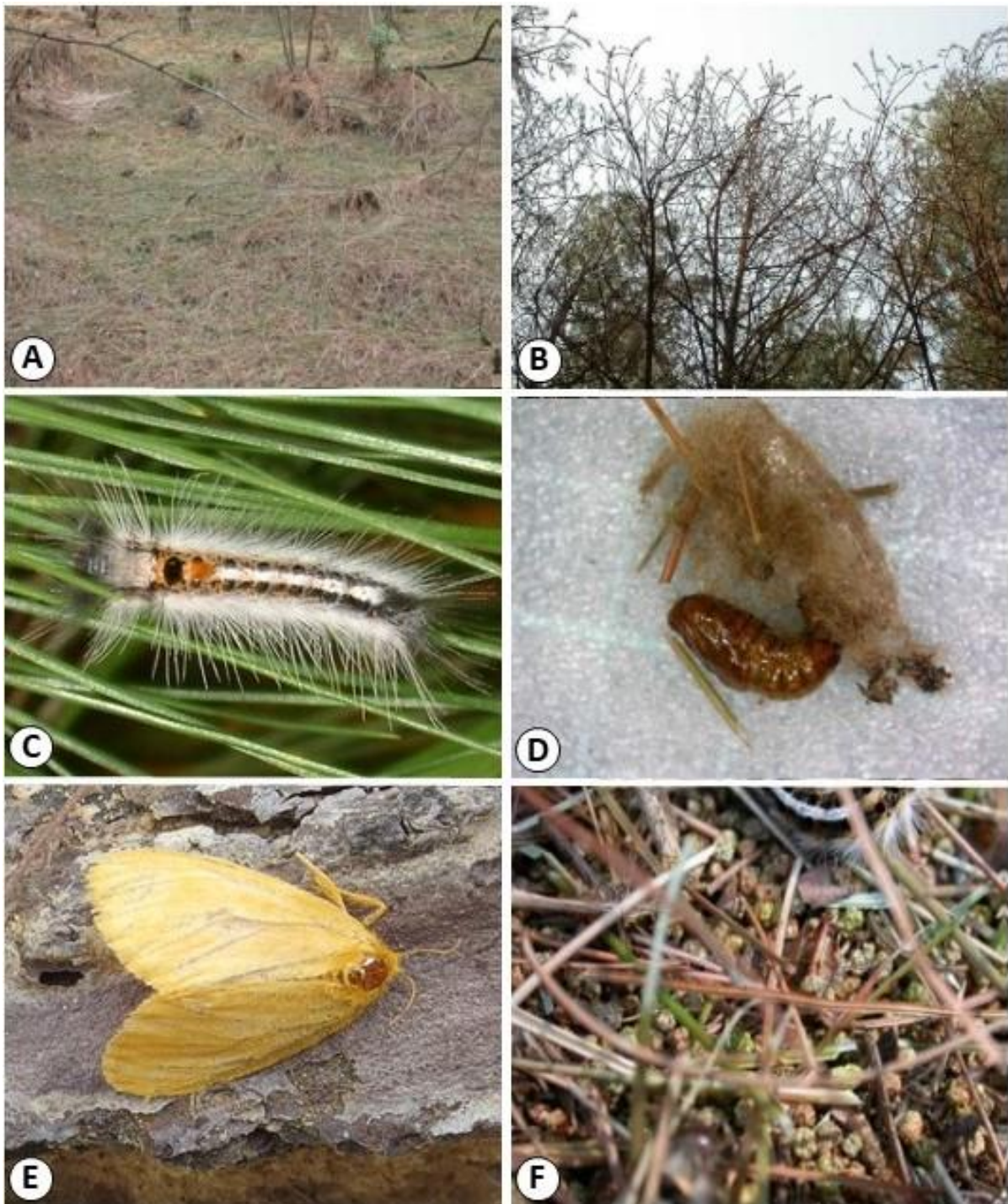

Figure 13. Pine brown tail moth and damage on pine trees. (A) Green needles on the plantation floor, (B) defoliation of crowns/bare crowns, (C) presence of hairy larvae on needles, stems and plantation floor, (D) pupae in needle mat and in soil of plantation floor, (E) yellow adult moth, (F) excrement pellets on the plantation floor.

3.1.4 Pine emperor moth

Insect: *Imbrasia cytherea* (relative of the mopane worm)

Hosts: Especially *Pinus patula* and *P. radiata*. Has also been reported from eucalypts and have been found feeding on GN near Greytown (2020, 2021).

Damage: Defoliation and stunted growth in repeated and severe cases of defoliation; tree mortality. Damage to commercial eucalypts is less known, and to date have been less severe, but some defoliation has been observed on GN.

Biology: Adult moths fly between January and May and lay eggs on needles and branches. The eggs are about 2mm in diameter, creamy white with brown to purplish markings. They are cemented in clusters of 3 to 40 eggs on terminal shoots and pine needles. Caterpillars hatch and start feeding on needles, causing defoliation during the winter months, starting around May. In spring, August/September, larvae drop to the plantation floor and pupate. Pupae are present under the needle mat for most of the summer. Moths emerge from the pupae from January onwards each year.

Symptoms/signs: Green needles on the forest floor (Figure 14A) are one of the first indications that caterpillars of the moth are present in the canopy. Infestations may lead to partial or total defoliation of trees (Figure 14B). In flight season large yellow/orange moths (Figure 14C) can be seen on the stems, needles, and plantation floor. The moths lay clusters of eggs on needles/leaves (Figure 14D). In autumn and winter caterpillars hatch and can be found feeding on the needles/leaves of trees (Figure 14E). Larvae will drop to the plantation floor and pupate under needle layers and in the soil (Figure 14F).

Management: Chemical pesticides have been applied and are available on the TIPWG and the Sappi APL. A male attractant pheromone was developed in the 1970s and tested for use by the TPCP. Although effective in trials, its commercial use needs to be optimized and trials are planned to test the pheromone for mating disruption.

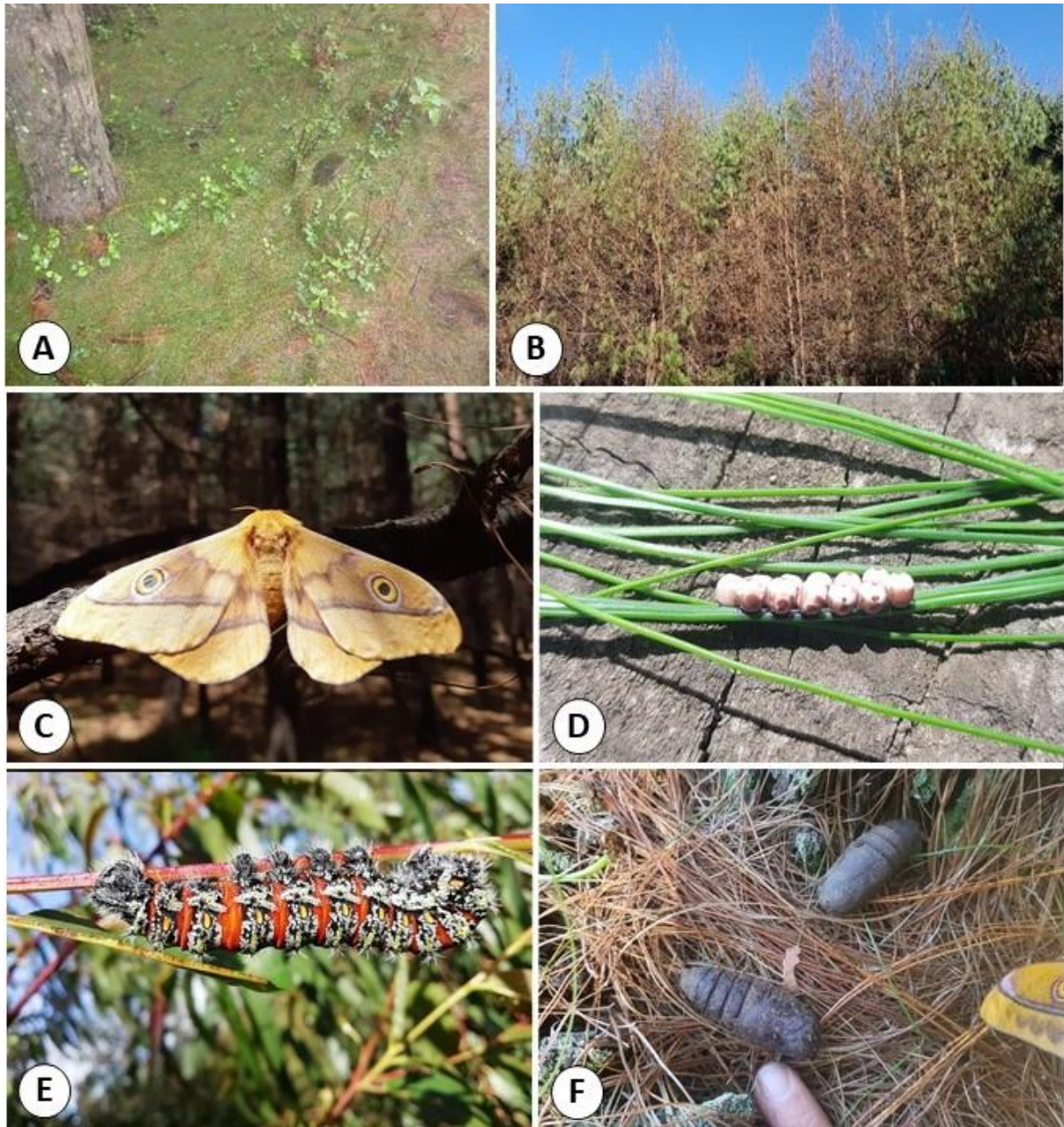

Figure 14. Emperor moth signs and symptoms on pines. (A) Green needles on the forest floor, (B) partial or total defoliation of trees, (C) emperor moth with typical round spots on wings, (D) egg packets on needles/leaves, (E) colourful caterpillars feeding on needles/leaves, (F) pupae found under needles, in soil.

sappi

3.1.5 Wattle bagworm

Insect: *Kotochalia junodi*

Hosts: *Acacia mearnsii* and native tree species.

Damage: Defoliation and stunted growth, if repeated defoliation occurs.

Biology: Caterpillars live in bags made from wattle leaves and silk. Females remain grub-like and feed directly from the bags. Males develop into moths and may be visible in the plantation.

Symptoms/signs: Caterpillars feed on leaves and may result in complete defoliation (Figure 15A) of trees. “Bags” constructed from wattle leaves and silk (Figure 15B) are visible on trees.

Management: Chemical pesticides have been applied and are available on the TIPWG and the Sappi APL.



Figure 15. Wattle bagworm on *Acacia mearnsii*. (A) Defoliation of tree crowns, (B) typical “bags” constructed from wattle pinnules on a black wattle tree.

sappi

sappi

3.1.6 Wattle mirid

Insect: *Lygidolon laevigatum*

Hosts: *Acacia mearnsii* and native tree species

Damage: Pinnule drop, malformation of shoots and tree stunting.

Biology: Nymphs and adults feed mostly on the young succulent growing tips of young trees, both the apical buds and pinnules. Mirids inject toxic saliva into the plant tissue and extracts sap from the plant. This results in tissue death leading to multiple shoots/branches and “witches broom” symptoms. When the apical buds are attacked, they die leading to the development of multiple shoots and loss of apical dominance. Eggs are laid between the pinnae of small developing leaves, or within the apical buds. Most damage occurs in summer, with a peak in late summer.

Symptoms/signs: Heavy infestations lead to a symptom called witches broom (Figure 16A), characterized by a bushy appearance due to loss of apical dominance. Tissue death due to mirid feeding is visible as red-brown spots on the pinnules and soft tissue of the trees. Pinnules may bend at point of tissue death (Figure 16B). Adult mirids are small insects of varying colour, ranging from black to brown with distinctive yellowish triangles on their abdomens (Figure 16C). Nymphs are green in colour.

Management: Chemical pesticides have been applied and are available on the TIPWG and the Sappi APL. Corrective pruning is possible.

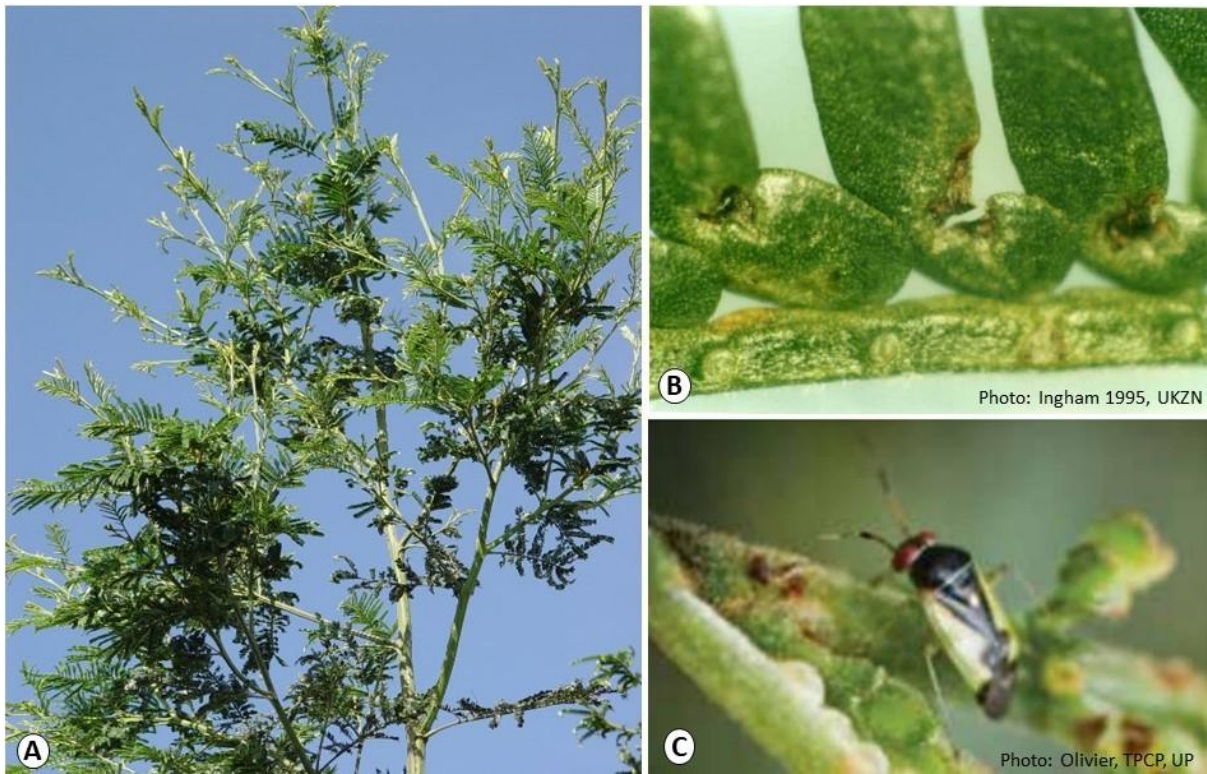

Figure 16. Wattle mirid and damage to *Acacia mearnsii*. (A) Witches broom characterized by a bushy appearance due to loss of apical dominance, (B) tissue death due to mirid feeding resulting in bending at point of feeding, (C) adult mirid with distinctive yellowish triangles on abdomen.

sappi

3.2 Stem pests

3.2.1 Cossid moth

Causal agent: *Coryphodema tristis*

Hosts: Only *Eucalyptus nitens*. Also attacks grape vines, quince and native Myrtaceae. The insect has been found on a single *Acacia mearnsii* tree in a *E. nitens* compartment.

Damage: Larval galleries cause structurally weakened timber and disruption of plant transport mechanisms, resulting in die-back, stem snapping/windfall, and tree mortality in severe infestations.

Biology: Female moths lay their eggs in bark crevices or cracks in the stem. After hatching, larvae spend the first 3-4 months feeding just beneath the bark. Thereafter they bore into the sapwood where they feed on the cambium for up to 18 months. Larvae are present throughout the year. Adults are nocturnal and fly from September through to December.

Symptoms/signs: Sawdust piles at the base of infested trees (Figure 17A) and/or collecting on branches. Peeling bark and large, round to oval emergence holes on the stem (Figure 17B), blackened stems with sawdust/frass and kino oozing from infection points and tunnels (Figure 17C, D), presence of larvae beneath the bark or in the sapwood (Figure 17E), presence of adults in infested compartments (Figure 17F).

NOTE: Blackened stems alone are not diagnostic of cossid moth infestation. Frass, kino exudation and/or sawdust piles should accompany blackened stems to indicate a cossid infestation.

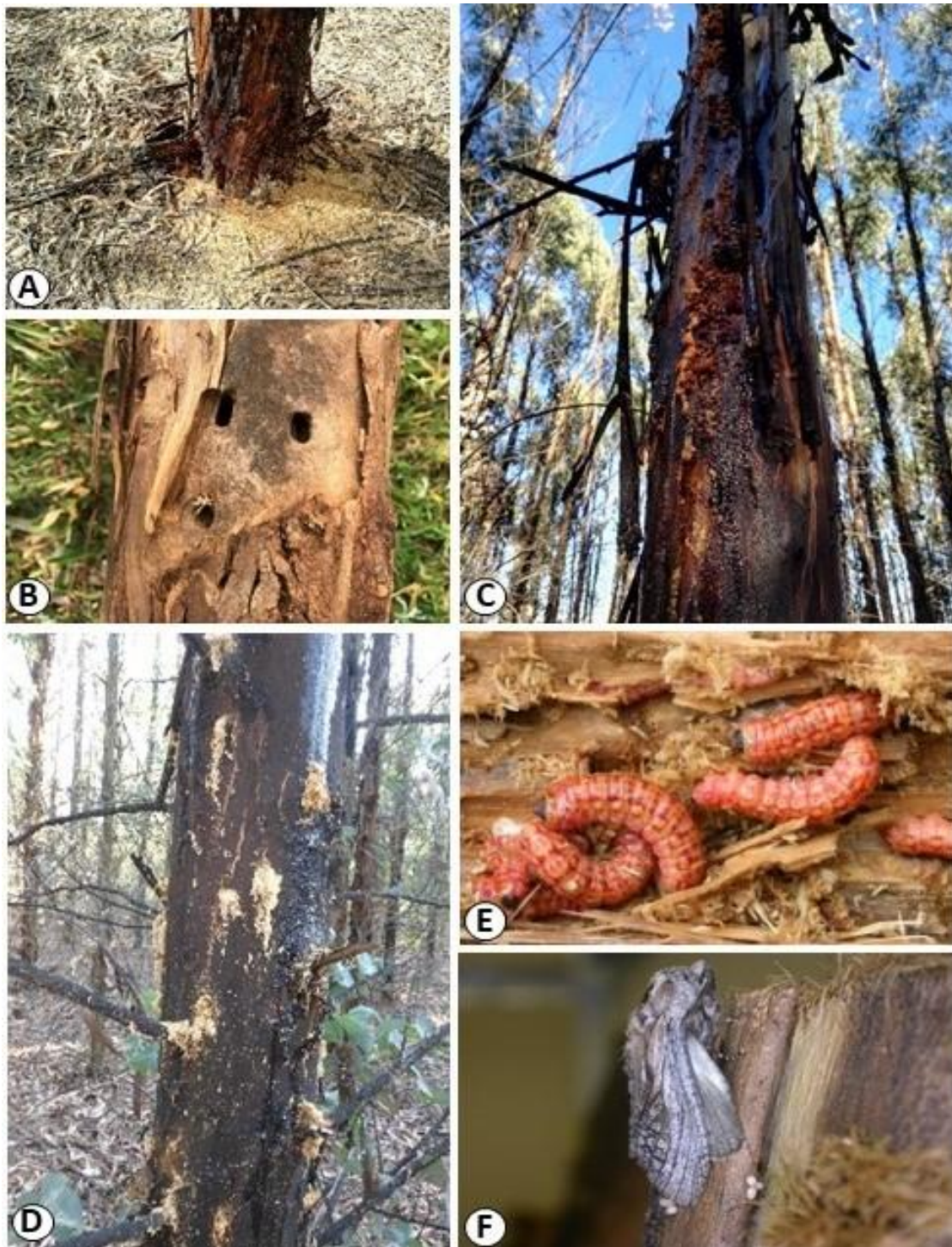

Figure 17. Cossid moth and typical damage on *E. nitens*. (A) Sawdust piles at the base of infested trees and/or collecting on branches and peeling bark, (B) large, round to oval emergence holes on stems, (C, D) blackened stems with sawdust/frass and kino oozing from infection points and tunnels, (E) cossid larvae in the wood, (F) adult cossid moth.

sappi

3.2.2 Deodar weevil

Causal agent: *Pissodes* species (previously known as *P. nemorensis*).

Hosts: *Pinus* species

Damage: The pine weevil breeds in dead or dying pine trees. The weevil also kills the leaders of young, healthy trees, which results in timber loss and malformation of trees (tip die-back). The pine weevil is suspected to be a potential vector of the pitch canker pathogen, *Fusarium circinatum*.

Biology: Pine trees of all ages can be attacked, usually during the winter months. It is especially associated with stressed trees, but it also actively feeds on vigorously growing trees. On vigorous trees the beetles make feeding punctures in the fresh growth of the leaders and lay eggs in the phloem. The larvae feed on the inner bark, girdling the leader, resulting in tip death. Pupation takes place in a chip-cocoon, constructed just below the bark. There are one to two generations a year.

Symptoms/signs: Oval emergence holes with compacted frass just under the bark (not going into sapwood) (Figure 18A), pupal chambers found under the bark (Figure 18B), feeding punctures on young stems and branches (Figure 18C), presence of adults, 5-10mm in size, with long rostrum on which antennae are positioned (Figure 18D), presence of white, C-shaped larvae beneath the bark (Figure 18E).

Management: Avoid off-site planting of trees to minimize attack of stressed trees. No other management currently available in South Africa.

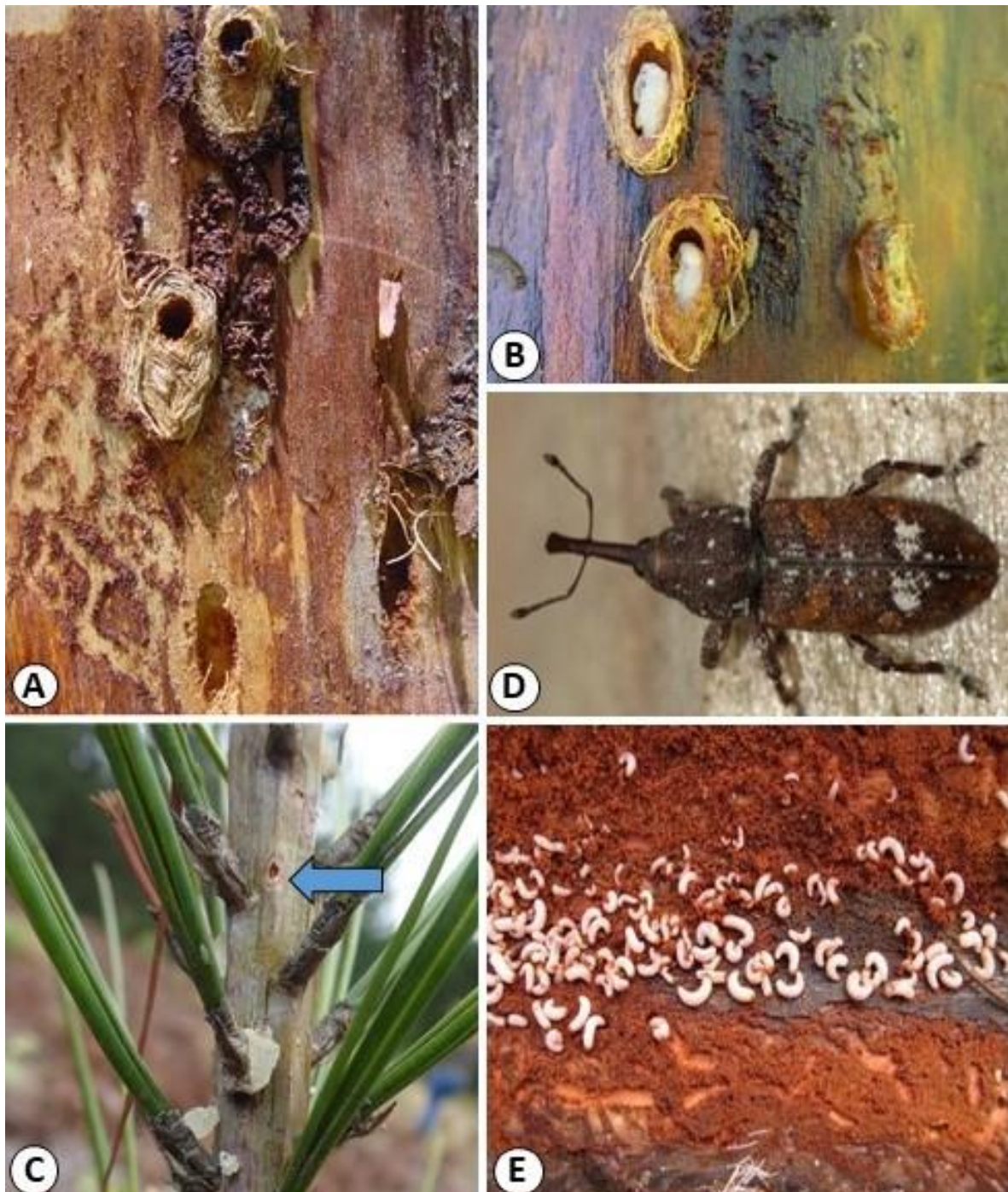

Figure 18. Pine deodar weevil, *Pissodes* sp., signs, and symptoms. (A) Oval emergence holes with compacted frass just under the bark (not going into sapwood), (B) pupal chambers under the bark, (C) feeding punctures on young stems and branches, (D) adult with long rostrum on which antennae are positioned, (E) white, C-shaped larvae beneath the bark.

3.2.3 Long-horned beetles

Causal agents: *Phoracantha semipunctata* and *P. recurva*

Hosts: *Eucalyptus* species, when under environmental stress, dying or already dead. If harvested trees are not debarked these beetles will infest the harvested logs.

Damage: Larvae initially feed on cambium and phloem layers, but also on the xylem (wood) later. Dying/stressed trees become ring-barked and structurally weakened due to larval feeding. Mostly a problem for saw timber and pole production.

Biology: Female beetles select trees that are dead, dying or under stress from drought, fire, or poor site conditions. Trees and logs which have been recently felled but not debarked also become infested. Eggs are laid under loose bark and the hatching larvae bore through the bark into the cambium. Most egg laying usually occurs between February and March. The larvae feed for two to four months before they bore into the heartwood where they pupate after ten days. Adult beetles live for a few months and are active throughout the year in warm areas, but on the Highveld their activity is reduced to the summer months.

Symptoms/signs: Early symptoms include kino exudation from stems and cracking of bark as larvae tunnel under the bark (Figure 19A), removing the bark reveals the presence of varying sizes of tunnels, tightly packed with sawdust/frass (Figure 19B, C), presence of adults, *P. semipunctata* (Figure 19C) and *P. recurva* (Figure 19D).

Management: Avoid off-site planting of trees. Debark trees at harvesting to prevent timber damage after harvesting. Biological control agents are present in South Africa, but the status of these insects in commercial forestry plantations are unknown.

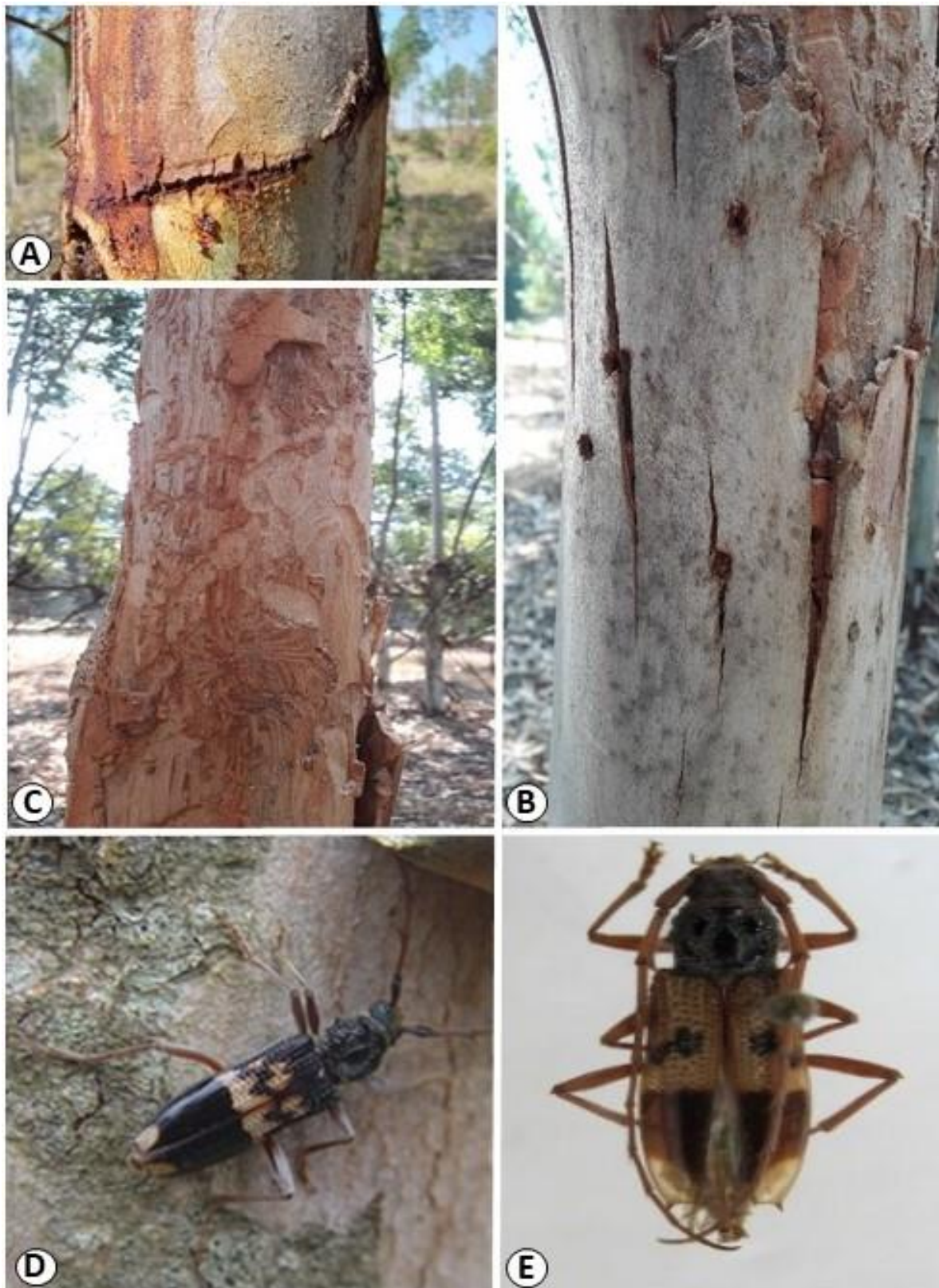

Figure 19. *Phoracantha* species on eucalypts. (A) Bark cracking and kino exudation from stem as larvae tunnel under the bark, (B), oval emergence holes in the bark, (C) removing the bark reveals the presence of varying sizes of tunnels, tightly packed with sawdust/frass, (D) adult *P. semipunctata*, (E) *P. recurva*.

sappi

3.2.4 Sirex wood wasp

Causal agent: *Sirex noctilio*

Hosts: Especially *Pinus patula* and *P. radiata*, but *P. taeda* and other species also susceptible.

Damage: Tree death as a result of toxic mucus and fungal rot of trees after mass attack by female wasps. When *Sirex* population levels are high they will also attack non-stressed trees. At the peak of *Sirex* infestations in KZN death of more than 30% of trees per compartment were recorded.

Biology: The *Sirex* female is attracted to stressed trees where she drills a hole through the bark into the sapwood. The female inserts a mucus and symbiotic fungus, *Amylostereum areolatum*, into the tree, and if the tree is suitable, will also deposit eggs. The eggs hatch and the larvae bore into the wood, feeding on the fungus. The larvae eventually pupate in the outer layers of the sapwood. Generally, there is one generation per year. The emergence period occurs from October to April, depending on the area. Mating takes place above the canopy. The female lives for approximately five days and the male for 12 days and neither feed during this time. When *Sirex* populations are low it is mostly sub-dominant trees that are attacked and those with double leaders and damage from other factors.

Symptoms/signs: Round emergence holes with compacted frass (Figure 20A), presence of adults in compartment: male with red band on abdomen (B), and female with visible ovipositor (arrow) (C), dying tree crowns (D), resin droplets (arrows) on stem indicating female oviposition sites (E), presence of larvae with characteristic black spine (arrow) on tail (F).

Management: The main control strategy against *Sirex* in South Africa relies on biological control. Two biological control agents, a parasitic nematode (*Deladenus siricidicola*) and a parasitoid wasp (*Ibalia leucospoides*) are released annually to keep *Sirex* levels below economic thresholds. Damage is heavier in pulp rotations due to high stocking and increased tree competition. In saw timber rotations, tree stress can be reduced by timely thinning operations.

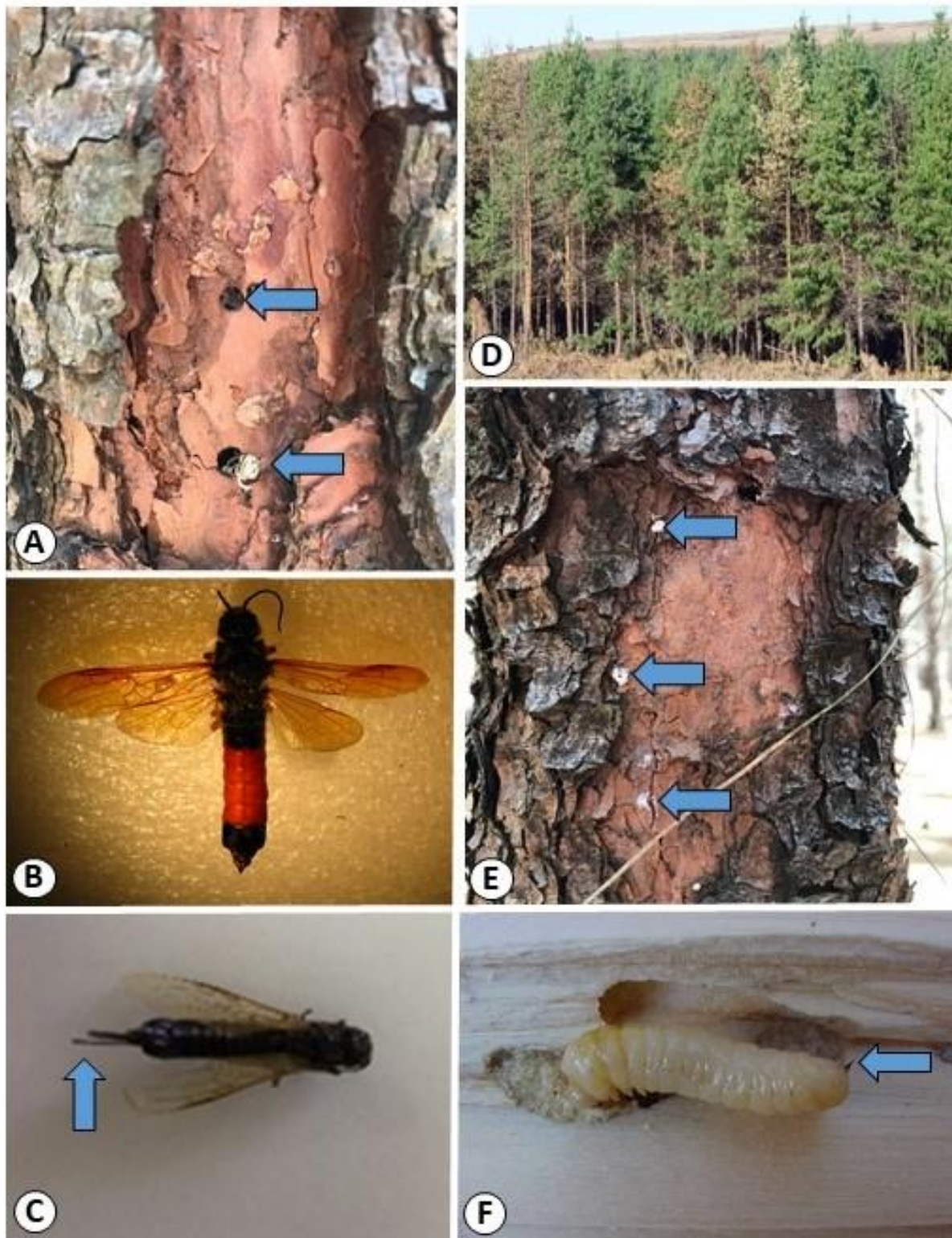

Figure 20. *Sirex noctilio* and damage to pines. (A) Round emergence holes, (B) adult male *Sirex* with red band on abdomen, (C) female with visible ovipositor (arrow), (D) dying tree crowns showing discoloration of entire canopy, (E) resin droplets (arrows) on stem indicating female oviposition sites, (F) presence of larvae with characteristic black spine (arrow) on tail.

sappi

3.3 Root and establishment pests

3.3.1 Cutworm

Causal agent: *Agrotis* species

Hosts: Various - *Eucalyptus*, *Acacia mearnsii*, *Pinus* and several agricultural crops.

Damage: Caterpillars feed on leaves, buds, and stems of young, recently planted trees. They may cut the stems of young plants completely, resulting in the falling over of plants. If not cut, the bark is eaten and the stem girdled, resulting in wilt, death or weak stems that break.

Biology: Cutworms are the larval stages of several noctuid moths (Lepidoptera: Noctuidae). These caterpillars live within the soil and emerge at night to feed on the leaves, buds, or stems of young trees. Eggs are laid on the soil, host plants and/or dead plant material near/at the base of the stem of the host plant during the summer months. During the day caterpillars hide in the soil near the stem of the last plant they fed on. They live 20-120 days depending on environmental conditions and food source. Caterpillars pupate in the soil. Moths fly during the night.

There are several generations of cutworm per year. Typically, eggs are laid during the early summer months. Caterpillars are present during early to late summer through winter, with pupae present during early spring. Adult moths are present during the early summer months

Symptoms/signs: Caterpillars (Figure 21A, B) are typically greyish black to greyish brown/green in colour, soft-bodied with a smooth skin and can measure up to 2.5 cm in length. Typically, the first observed sign of cutworm infestation is fallen over plants due to cut stems (Figure 21C). Closer inspection on standing plants may reveal bark feeding and caterpillars in the planting pit (Figure 21D).

Management: Chemical insecticides are on the TIPWG and the Sappi APLs for control of cutworm before or after emergence.

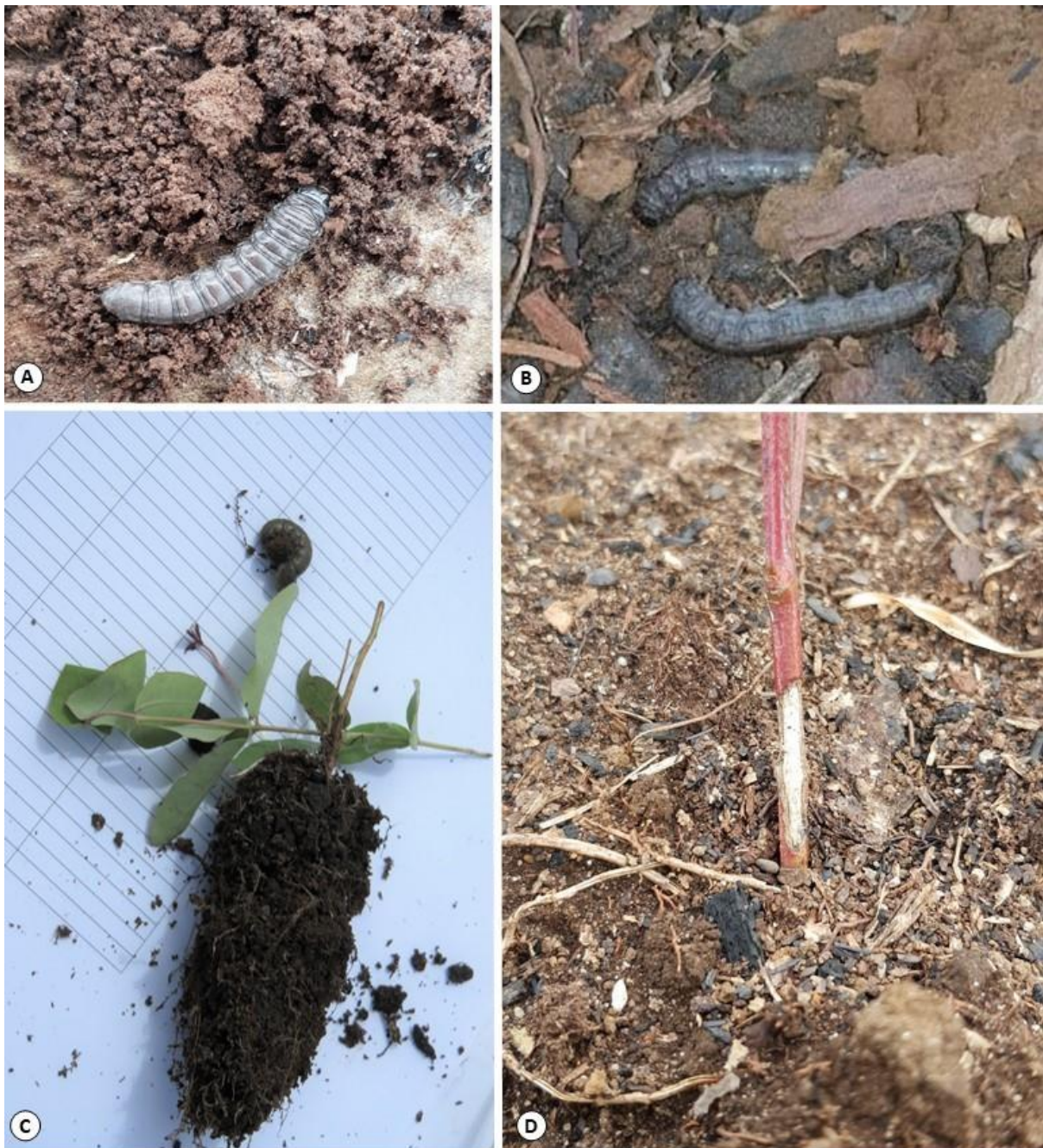

Figure 21. Cutworm and damage to eucalypt plants. (A, B) Cutworm caterpillars, (C) cut stem of a young *E. dunnii* seedling, (D) cutworm feeding on stem of eucalypt plant.

3.3.2 White grub

Causal agents: Various species of Scarab beetle larvae.

Hosts: All commercially planted *Eucalyptus*, *Pinus*, and *Acacia* spp.

Damage: Grubs are compost feeders and are attracted to the root plugs of planted seedlings. During feeding the roots and cambium of the lower stem are consumed as well. The adult beetles may feed on the leaves of trees irrespective of age.

Biology: White grubs are soil-dwelling larvae of various Scarabaeidae beetles (Scarabs) that feed on the roots and cambium of the lower stem of young seedlings and cuttings. During September to January, eggs are laid in humus rich soil and hatch after two to three weeks. The grubs pupate after a year or two depending on the species and the adults will emerge after spring rains.

Symptoms/signs: Wilting of plants (Figure 22A), missing roots due to grubs feeding on roots (Figure 22B, C), presence of white, C-shaped larvae, with legs on front part of body, in the soil/planting pit near the root system (Figure 22D).

Management: Chemical insecticides are on the TIPWG and the Sappi APLs for control of white grub. Apply at planting.



Figure 22. White grub damage to eucalypts. (A) Wilting of plants, (B, C) missing roots due to grubs feeding on roots, (D) white, C-shaped larvae, with legs on front part of body, in the soil/planting pit near the root system.

3.4 OTHER PESTS

Several other insects sporadically attack eucalypts, pines, and wattles in plantations (Figure 23).

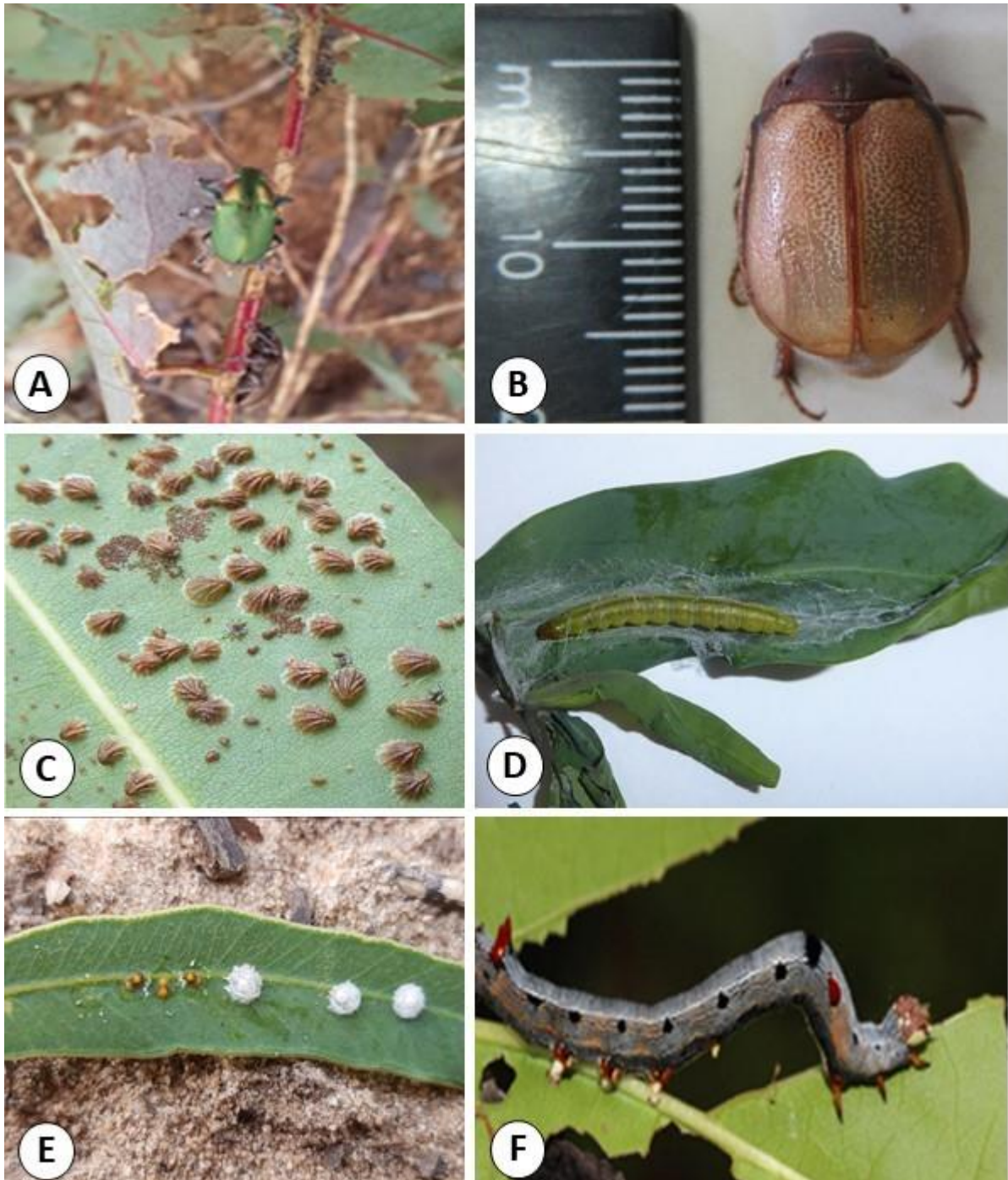

Figure 23. (A) *Colasposoma* sp. (green bronze) beetle, (B) Chafer beetle, (C) Shell lerp psyllid, (D) Eucalypt leaf roller, (E) Red gum lerp psyllid, (F) Wattle semi-looper.

3.5 DAMAGE-CAUSING ANIMALS

Damage-causing animals (e.g., baboons, bush pigs, antelope, rodents, and domestic livestock) can pose a significant threat to the productivity of plantations and should be controlled according to recommended protocols and in line with legislation. As in the case of pests and diseases, and integrated approach should be followed.



Photo 1: Kudu (left) and eland (right) damage on pine.¹



Photo 2: Eland damage on pine.³



Photo 3: Baboon damage on pine.²



Photo 4: Ringbarking of pine by rodents.



Photo 5: Raptor perch for the control of rodents.¹

References

- ¹ Photos by A Jooste.
- ² Photos by I Germishuizen.
- ³ Photo by G McKenzie.